

Descrizione Description	Articolo Product code	Finiture Finishes				Misure mm Measures mm										Packaging			Note		
		IN	IT	BB		A	A2	B	C	Ø	D	E	F	G	H	U.M.	Pack	Kg			
Modello / Model <b>Piolo per persiana con battuta a conficcare</b> Stake for shutters with travel limiter for driving in	<b>FSP 00463 N0</b>	●	●	●		55				7							pcs	40	1,4		
Modello / Model <b>Piolo per persiana con battuta a vite</b> Stake for shutters with travel limiter with screw	<b>FSP 00463 V0</b>	●	●	●		60				7							pcs	40	1,4		
Modello / Model <b>Piolo per persiana con battuta a vite ad angolo</b> Stake for shutters with travel limiter with angled screw	<b>FSP 00463 I0</b>	●	●	●		75		25		7							pcs	40	2,1		
Modello / Model <b>Piolo per persiana con battuta ad avvitare a cannocchiale</b> Stake for shutters with travel limiter for screwing in	<b>FSP 00463 H0</b>	●	●			18		14	5	8							pcs	40	0,6		
Modello / Model <b>Fermo per persiana senza battuta con mezzaluna a marmo</b> Securing stop with half-moon for shutters without travel limiter	<b>FSP 00464 G4</b> <b>FSP 00464 G1</b>	●	●	●		28		35		10	14						pcs	40	3,6	mod. 400 _	
Modello / Model <b>Fermo per persiana senza battuta con mezzaluna a vite</b> Securing stop with half-moon with screw for shutters without travel limiter	<b>FSP 00464 V4</b> <b>FSP 00464 V1</b>	●	●			28		35		5	14						pcs	40	3,6	mod. 400 _	

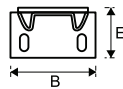
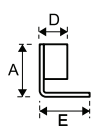
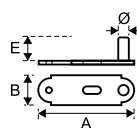
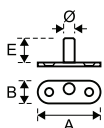

**IN** ferro fondo zincato e copertura polveri poliesteri nero RAL 9005  
zinc treatment iron black powder coating

**IT** ferro tropicalizzato  
yellow zinc iron

**BB** ottone brunito  
brunished brass

Modello / Model

**Piolo per persiana con  
battuta a conficcare**  
*Stake for shutters with  
travel limiter for driving in*



Modello / Model

**Piolo per persiana con  
battuta a vite**  
*Stake for shutters with  
travel limiter with screw*



Modello / Model

**Piolo per persiana con  
battuta a vite ad angolo**  
*Stake for shutters with  
travel limiter with angled screw*



Modello / Model

**Piolo per persiana con  
battuta ad avvitare  
a cannocchiale**  
*Stake for shutters with  
travel limiter  
for screwing in*



Modello / Model

**Fermo per persiana senza  
battuta con mezzaluna  
a marmo**  
*Securing stop with half-moon  
for marble for shutters without  
travel limiter*



ESEMPIO APPLICATIVO Nr. 14 Pag. 312  
EXAMPLE OF APPLICATION No. 14 Page 312

Modello / Model

**Fermo per persiana senza  
battuta con mezzaluna  
a vite**  
*Securing stop with half-moon  
with screw for shutters without  
travel limiter*



ESEMPIO APPLICATIVO Nr. 14 Pag. 312  
EXAMPLE OF APPLICATION No. 14 Page 312

Descrizione Description	Articolo Product code	Finiture Finishes				Misure mm Measures mm										Packaging			Note	
		IN	IT	BB	IW	A	A2	B	C	Ø	D	E	F	G	H	U.M.	Pack	Kg		
Modello / Model <b>Piolo per persiana con battuta ad avvitare</b> Stake for shutters with travel limiter for screwing in	<b>FSP 00463 L0</b>	●	●	●		40		14		7		18					pcs	40	1,4	
Modello / Model <b>Piolo per persiana con battuta ad avvitare registrabile</b> Adjustable stake for shutters with travel limiter for screwing in	<b>FSP 00463 R0</b>	●	●	●		64		20				18					pcs	40	2,6	
	<b>FSP 00463 P0</b>	●	●	●		105		20				18					pcs	40	4,5	
	<b>VSP 00463 23</b>	●	●			155		20				18					pcs	100	6,3	
	<b>VSP 00463 22</b>	●	●			200		20				18					pcs	50	4,2	
Modello / Model <b>Fermo per persiana senza battuta ad avvitare</b> Securing stop for shutters without travel limiter	<b>FSP 00464 F1</b>	●	●			27,5		45			10	28					pcs	40	4,1	mod. 100 __
	<b>FSP 00464 T1</b>	●	●			27,5		45			10	55					pcs	40	4,1	mod. 100 __
	<b>FSP 00464 F4</b>	●	●	●		27,5		45			14	28					pcs	40	4,4	mod. 400 __
	<b>FSP 00464 T4</b>	●	●	●		27,5		45			14	55					pcs	40	4,4	mod. 400 __
Modello / Model <b>Supporto per cappotto per pioli spagnolette</b> Stirrup for insulating layer for espagnolettes stakes	<b>FSP 000TU 3Z</b>				●	120						2					pcs			
	<b>FSP 000TU 4Z</b>				●	200						2					pcs			

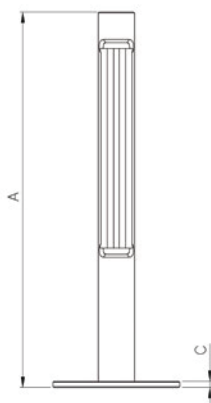
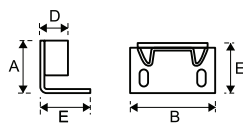
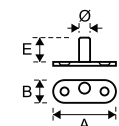

- IN** ferro fondo zincato e copertura polveri poliesteri nero RAL 9005  
zinc treatment iron black powder coating
- IT** ferro tropicalizzato  
yellow zinc iron
- BB** ottone brunito  
brunished brass

Modello / Model

**Piolo per persiana con  
battuta ad avvitare**  
*Stake for shutters with  
travel limiter for screwing in*

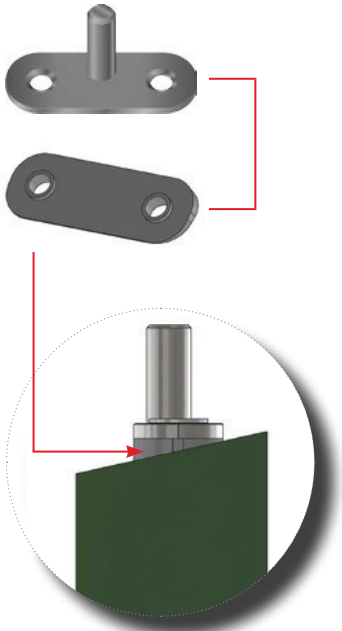

SPESSORE PER INSTALLAZIONE SU PROFILO OBLIQUO  
THICKNESS FOR INSTALLATION ON OBLIQUE PROFILE

Modello / Model

**Piolo per persiana con  
battuta ad avvitare  
registrabile**  
*Adjustable stake for shutters  
with travel limiter for screwing in*



Modello / Model

**Fermo per persiana senza  
battuta ad avvitare**  
*Securing stop for shutters  
without travel limiter for  
screwing in*

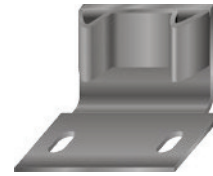

ESEMPIO APPLICATIVO Nr. 14 Pag. 312  
EXAMPLE OF APPLICATION No. 14 Page 312

Modello / Model

**Supporto per cappotto  
per pioli spagnolette**  
*Stirrup for insulating layer  
for espagnolettes stakes*



ESEMPIO APPLICATIVO Nr. 13 Pag. 312  
EXAMPLE OF APPLICATION No. 13 Page 312

