

Descrizione Description	Articolo Product code	Finiture Finishes				Misure mm Measures mm										Packaging			Note
		IN	IE	IT	BB	A	A2	B	C	Ø	D	E	F	G	H	U.M.	Pack	Kg	
Serie / Series 704 Modello / Model Gambo a vite perno sfilabile per bandelle alla mestrina con grano di sicurezza Screw leg removable pin for "mestrina" style hinges with securing screw																			
M 10x25 Ø 10	FCA 00704 GV	●		●	●	36	25	30	18	10		66		10		pcs	50	4,1	
M 10x60 Ø 10	FCA 00704 G9	●		●	●	68	60	30	18	10		66		10		pcs	40	3,6	
M 12x85 Ø 10	FCA 00704 G1	●		●		94	85	30	18	10		66		12		pcs	30	5,2	
Serie / Series 704 Modello / Model Gambo a vite perno sfilabile con grano di sicurezza Screw leg removable pin with securing screw																			
M 10x25 Ø 12	FCA 00704 HV	●		●		35	25	30	20	12		70		10		pcs	40	4,8	
M 12x100 Ø 12	FCA 00704 HB	●		●		110	100	30	20	12		70		12		pcs	40	7,0	
M 12x145 Ø 12	FCA 00704 01	●		●		155	145	30	20	12		70		12		pcs	30		
M 14x200 Ø 12	FCA 00704 0P	●		●		210	200	30	20	12		70		14		pcs	30		
Serie / Series 704 Modello / Model Gambo a vite perno sfilabile per bandelle alla padovana e alla vicentina con grano di sicurezza Screw leg removable pin for padua and vicenza style hinges with securing screw																			
M 10x60 Ø 7	FCA 00704 N9	●		●		67	60	18	14	7		35		10		pcs	72	4,0	
M 10x25 Ø 7	FCA 00704 NV	●		●		36	28	18	14	7		35		10		pcs	96	4,2	

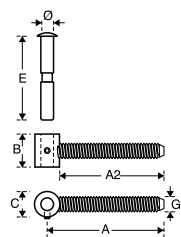

- IN** ferro fondo zincato e copertura polveri poliesteri nero RAL 9005
zinc treatment iron black powder coating
- IT** ferro tropicalizzato
yellow zinc iron

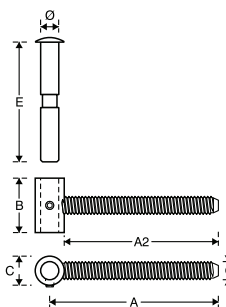

Serie / Series
704

Modello / Model
**Gambo a vite
perno sfilabile
per bandelle
alla Mestrina con
grano di sicurezza**
*Screw leg removable
pin for "Mestrina"
style hinge*

Dimensioni / Dimensions available
gambo / stem - perno / pin
M10 × 25 - Ø10 (1) - per vers. 353
M10 × 60 - Ø10 (2) - per vers. 353
M12 × 85 - Ø10 (3) - per vers. 353



(1) ARTICOLO DA UTILIZZARE IN ABBINAMENTO AL TASSELLO METALLICO COD.FCA000TU1T/2T (VEDI PAG. 141)
PRODUCT TO USE COMBINING WITH METAL PLUG COD.FCA000TU1T/2T (SEE PAGE 141)
(2) ARTICOLO DA UTILIZZARE IN ABBINAMENTO AL TASSELLO METALLICO COD.FCA000TU1Z (VEDI PAG. 141)
PRODUCT TO USE COMBINING WITH METAL PLUG COD.FCA000TU1Z (SEE PAGE 141)
(3) ARTICOLO DA UTILIZZARE IN ABBINAMENTO AL TASSELLO METALLICO COD. FCA000TU2Z (VEDI PAG. 141)
PRODUCT TO USE COMBINING WITH METAL PLUG COD.FCA000TU2Z (SEE PAGE 141)



ESEMPIO APPLICATIVO Nr.
5 - 7 - 8 Pag. 316 - 317
EXAMPLE OF APPLICATION
No. 5 - 7 - 8 Page 316 - 317



Serie / Series
704

Modello / Model
**Gambo a vite
perno sfilabile
con grano di
sicurezza**
*Screw leg
removable pin
with securing
screw*

Dimensioni / Dimensions available
gambo / stem - perno / pin
M10 × 25 - Ø 12
M12 × 100 - Ø 12
M12 × 145 - Ø 12
M14 × 200 - Ø 12



Testa antisfilamento anta

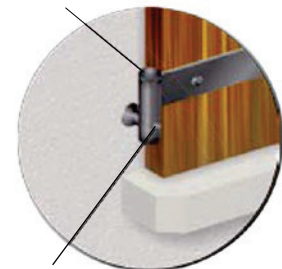

Grano di sicurezza

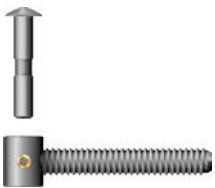

Serie / Series
704

Modello / Model
**Gambo a vite
perno sfilabile per
bandelle padovana
e vicentina**
*Screw leg
removable pin for padua
and vicenza style hinge*

Dimensioni / Dimensions available
gambo / stem - perno / pin
M10 × 60 - Ø7 (1) - per vers. 353
M10 × 25 - Ø7 (2) - per vers. 353



(1) ARTICOLO DA UTILIZZARE IN ABBINAMENTO AL TASSELLO METALLICO COD.FCA000TU1T/2T (VEDI PAG. 141)
PRODUCT TO USE COMBINING WITH METAL PLUG COD.FCA000TU1T/2T (SEE PAGE 141)
(2) ARTICOLO DA UTILIZZARE IN ABBINAMENTO AL TASSELLO METALLICO COD.FCA000TU1Z (VEDI PAG. 141)
PRODUCT TO USE COMBINING WITH METAL PLUG COD.FCA000TU1Z (SEE PAGE 141)



ESEMPIO APPLICATIVO Nr. 9 -
10 Pag. 317
EXAMPLE OF APPLICATION No.
9 - 10 Page 317



QUESTO CARDINE E' DOTATO DI GRANO DI BLOCCAGGIO ANTI RIMOZIONE DEL PERNO
THIS PINTEL IS EQUIPPED WITH ANTI-REMOVAL PIN SECURING SCREW

Descrizione Description	Articolo Product code	Finiture Finishes				Misure mm Measures mm										Packaging			Note				
		IN	IE	IT	BB	A	A2	B	C	Ø	D	E	F	G	H	U.M.	Pack	Kg					
Serie / Series 704																							
Modello / Model Gambo a muro perno sfilabile boccola passante con grano di sicurezza	G. 14x200 Ø 12	FCA 00704 HA	●		●			200	210	30	20	12	60	75		14				pcs	20	7,0	
<i>Wall leg removable pin with securing screw</i>	G. 14x250 Ø 12	FCA 00704 H1	●		●			260	250	30	20	12	70	75		14				pcs	20	8,0	

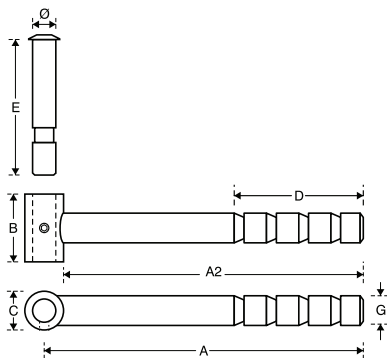

Serie / Series
704

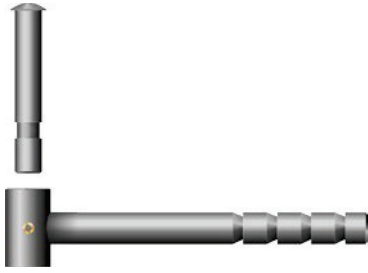

Modello / Model
**Gambo a muro
perno sfilabile
boccola passante
con grano
di sicurezza**
*Wall leg removable pin
with securing screw*

Dimensioni / Dimensions available
gambo / stem - perno / pin
G. 14 × 200 - Ø 12
G. 14 × 250 - Ø 12



PER LA SCELTA DEL PRODOTTO VEDI PAG. 320
FOR PRODUCT PICKING SEE PAGE 320



Testa antisfilamento anta
Anti-removal head pin

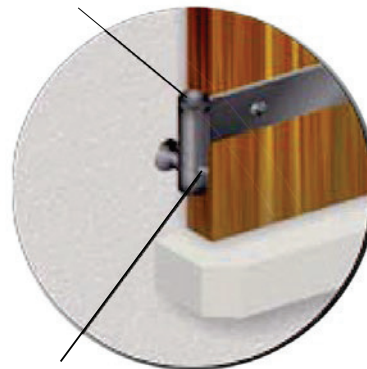

Grano di sicurezza
Securing screw

IN ferro fondo zincato e copertura
polveri poliesteri nero RAL 9005
*zinc treatment iron black powder
coating*

IT ferro tropicalizzato
yellow zinc iron



QUESTO CARDINE E' DOTATO DI GRANO DI BLOCCAGGIO ANTI RIMOZIONE
DEL PERNO
THIS PINTEL IS EQUIPPED WITH ANTI-REMOVAL PIN SECURING SCREW