











306 □ Z0 14 □









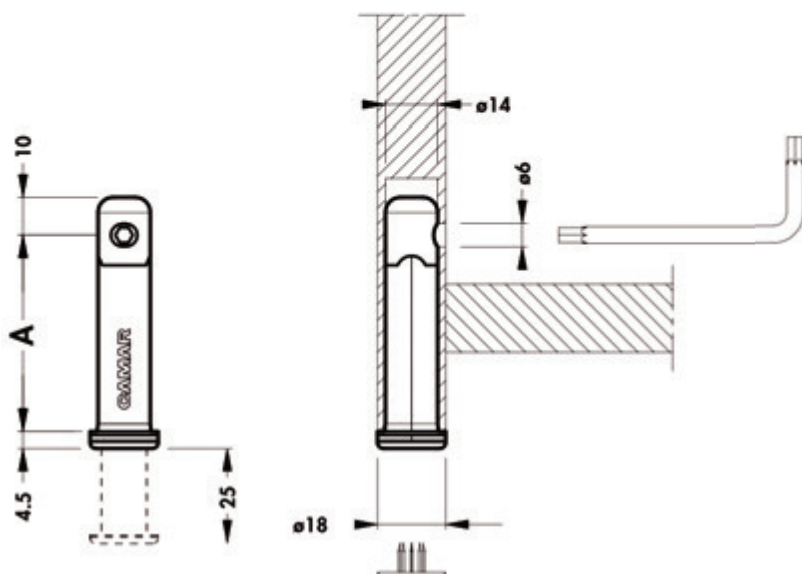

New	02 = 25 ▲	P0	 41
	02 = 25 ■	00	
	05 = 52	00	
	07 = 70	00	
	12 = 120	00	
	14 = 140 *	00	
	Amm		



A _{mm} 25=	+10mm 0mm	A _{mm} 52-140=	+25mm 0mm	Ø14mm
				ZAMAK
A _{mm} 52-140=	LGA			

 100	 4800	 800
▲  200	 9600	
*  50		



		809  536-537
	810 00 02 20 25	 539
	Amm 25 ■	
	810 18 02 00 00	 545
	810 20 02 00 00	 546
	Amm 52 - 140	
	306 00 AL MA 00	 517