



Per porte a filo

Portata con 3 cerniere 60 kg

Portata con 2 cerniere 50 kg

Regolabile +/- 3mm in altezza, +/- 3mm in lateralmente e +/- 1mm in profondità



Articolo	Materiale	Finitura	Ore neb. Salina	Imballo
1363508	Acciaio e Zama	Cromato opaco	22	3
1364563	Acciaio e Zama	Simil inox	22	3
1368013	Acciaio e Zama	Zincato GSS	310	3

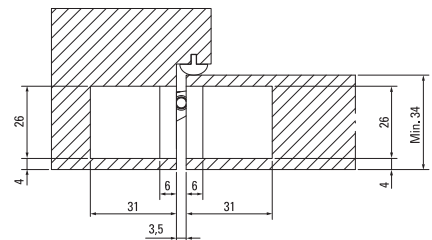

a1 mm	a2 mm	a3 mm	b1 mm	b2 mm	c mm
26,0	31,0	6,0	134,0	111,0	15,0

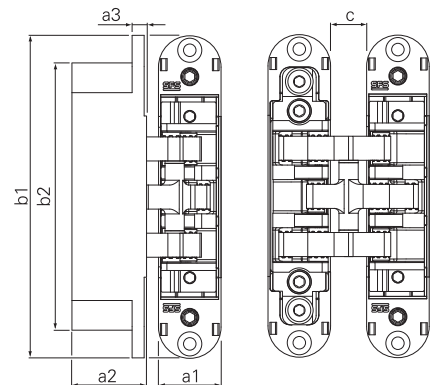

Registered design & Patent pending

**possibili abbinamenti**



WTEC-3D-60T00	WTEC-3D-60P00	BA-W-Tec-3D
p. 10.2 2	p. 10.2 1	p. 10.3 6