

Guarnizioni per Vetro

For Glass / Pour Le Verre / Para El Vidrio

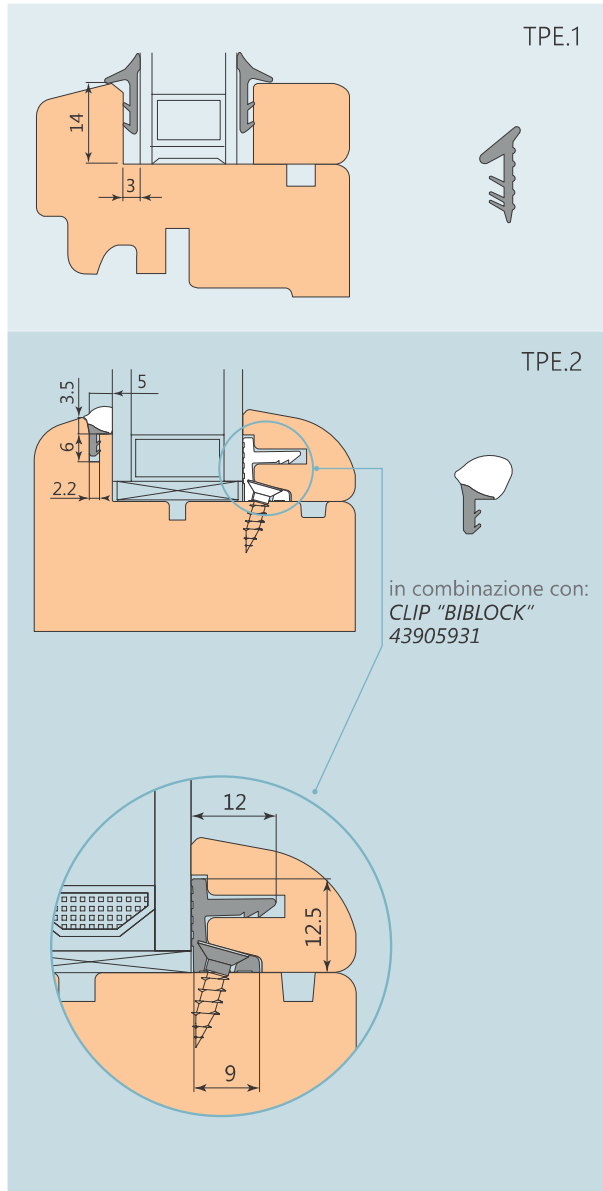

Colore
Colour

Codice
Code

Quantità per imballo
Packaging quantity

Quantità per pallet
Pallet quantity



15000334.11

200 m

4.000 m



15000334.12

200 m

4.000 m



15000334.13

200 m

4.000 m



15000930.11

400 m

8.000 m



15000930.12

400 m

8.000 m



15000930.13

400 m

8.000 m



15000930.50

400 m

8.000 m

Cava Ferramenta

Hardware / Quincaillerie / Herramienta

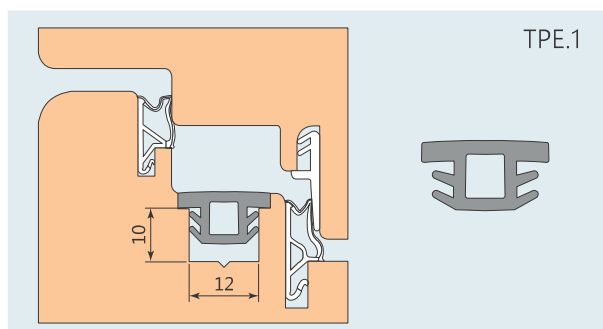

Colore
Colour

Codice
Code

Quantità per imballo
Packaging quantity

Quantità per pallet
Pallet quantity



15000778.26

264 m

4.224 m











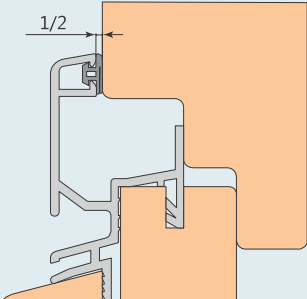



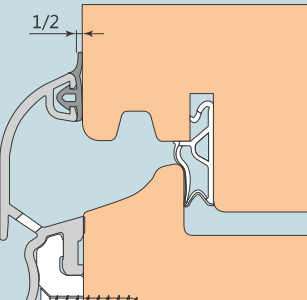

GUARNIZIONI PROFILI VARI

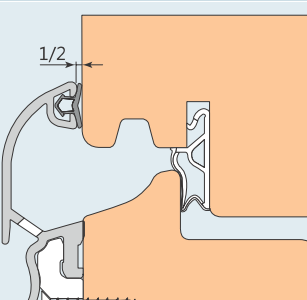
VARIOUS GASKETS / DIVERS JOINTS / VARIAS JUNTAS



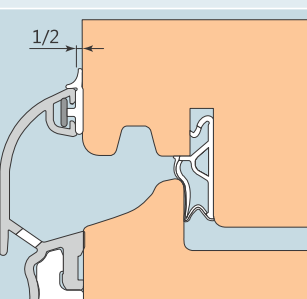









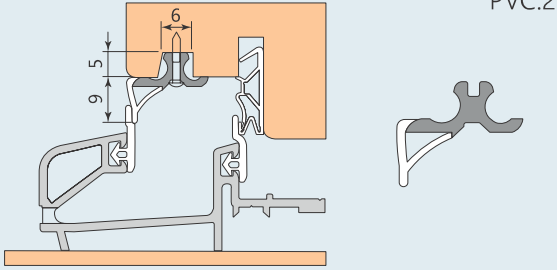



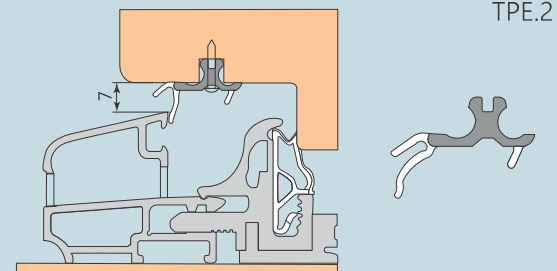



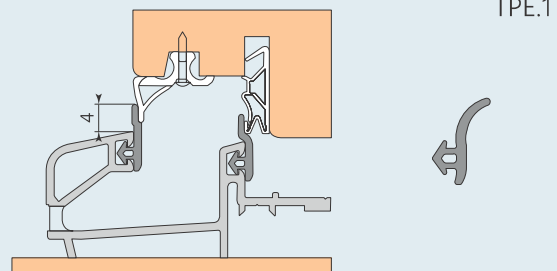

Per Gocciolatoi

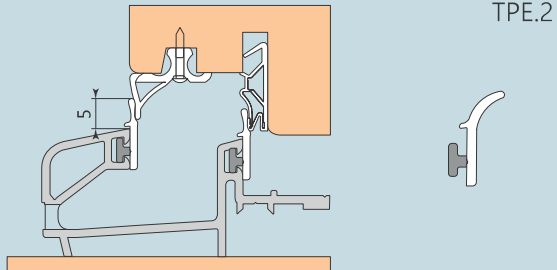
For Drip Mouldings / Pour Rejets D'eau / Para Goterones Vierteaguas

	Colore Colour	Codice Code	Quantità per imballo Packaging quantity	Quantità per pallet Pallet quantity
 <p>1/2</p> <p>TPE.1</p> 		15000306.11	250 m	7.500 m
		15000306.12	250 m	7.500 m
		15000306.13	250 m	7.500 m
 <p>1/2</p> <p>TPE.1</p> 		15000980.11	350 m	7.000 m
		15000980.12	350 m	7.000 m
		15000980.13	350 m	7.000 m
 <p>1/2</p> <p>TPE.1</p> 		15000368.11	250 m	7.500 m
		15000368.12	250 m	7.500 m
		15000368.13	250 m	7.500 m
 <p>1/2</p> <p>TPE.2</p> 		15000972.11	200 m	2.000 m
		15000972.12	200 m	2.000 m
		15000972.13	200 m	2.000 m

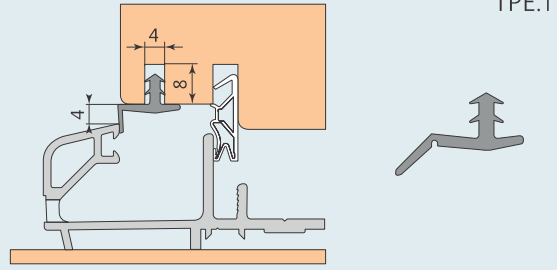
Guarnizioni per Soglie

For Thresholds / Pour Seuils / Para Umbrales

	Colore Colour	Codice Code	Quantità per imballo Packaging quantity	Quantità per pallet Pallet quantity
 <p>PVC.2</p>		11000738.11	150 m	3.000 m
		11000738.12	150 m	3.000 m
		11000738.13	150 m	3.000 m
 <p>TPE.2</p>		15000938.11	150 m	3.000 m
		15000938.12	150 m	3.000 m
		15000938.13	150 m	3.000 m
 <p>TPE.1</p>		15000736.11	300 m	6.000 m
		15000736.12	300 m	6.000 m
		15000736.13	300 m	6.000 m
 <p>TPE.2</p>		15000932.11	300 m	6.000 m
		15000932.12	300 m	6.000 m
		15000932.13	300 m	6.000 m
 <p>TPE.1</p>		15000758.11	180 m	3.600 m
		15000758.12	180 m	3.600 m
		15000758.13	180 m	3.600 m