

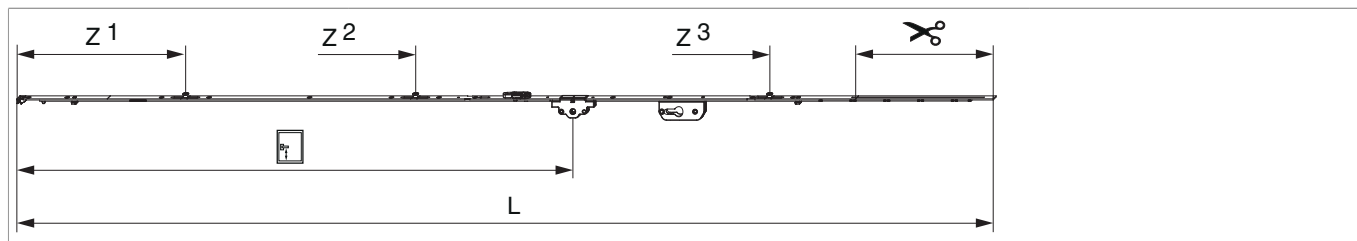

205629 - Cremonese Multi Matic 2200 E35 fix bloccabile con cilindro con 3 funghi HBB 1.951-2.200 HM1.050 argento

Disegni tecnici



							L		Nº
argento	2200	35	1.050	1.951 - 2.200	260,5	1	2.096,5	10	205629

Tabella posizionamento viti

Nº		1	2	3	4	5	6	7	8	9	10	11	12	13	14
205629	12	18,5	91,5	270	360	550	705	795	863,5	1.124	1.388	1.465	1.729		

Tabella punti di chiusura

Nº		Z1	Z2	Z3	Z4
205629	3	315	750	1.420	

Quote della scatola cremonese

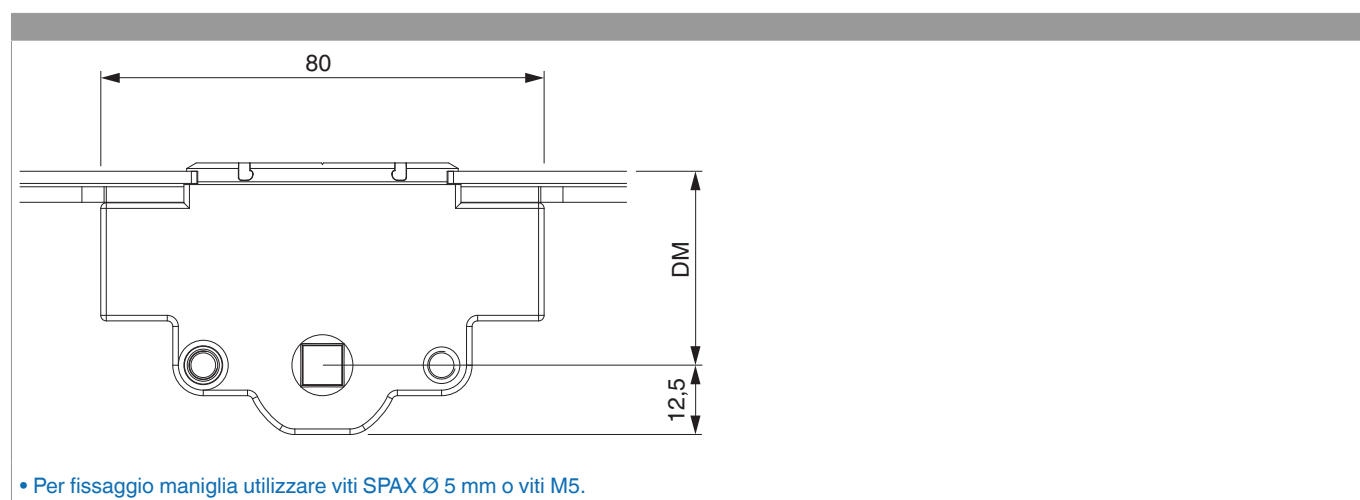

Quote scatola serratura

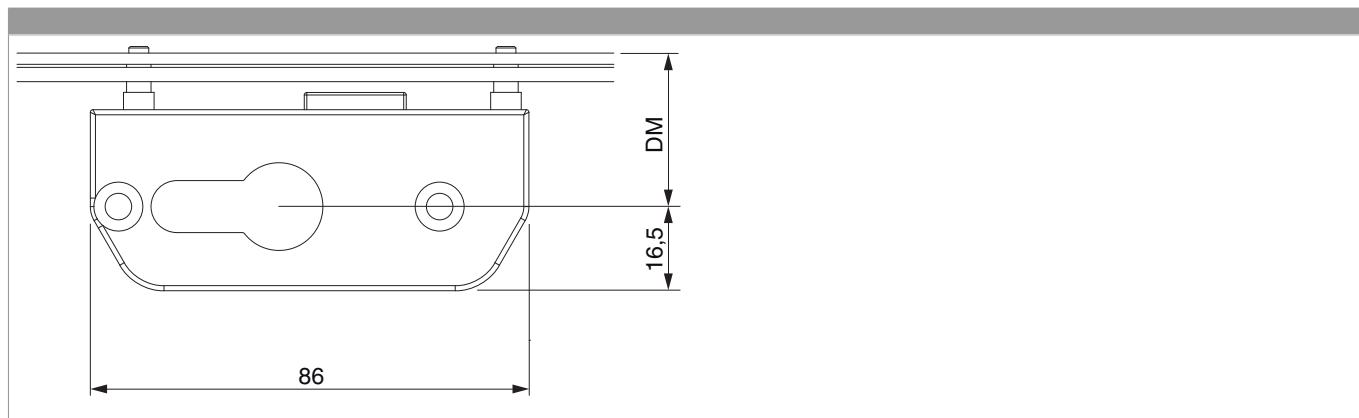

Schema di foratura

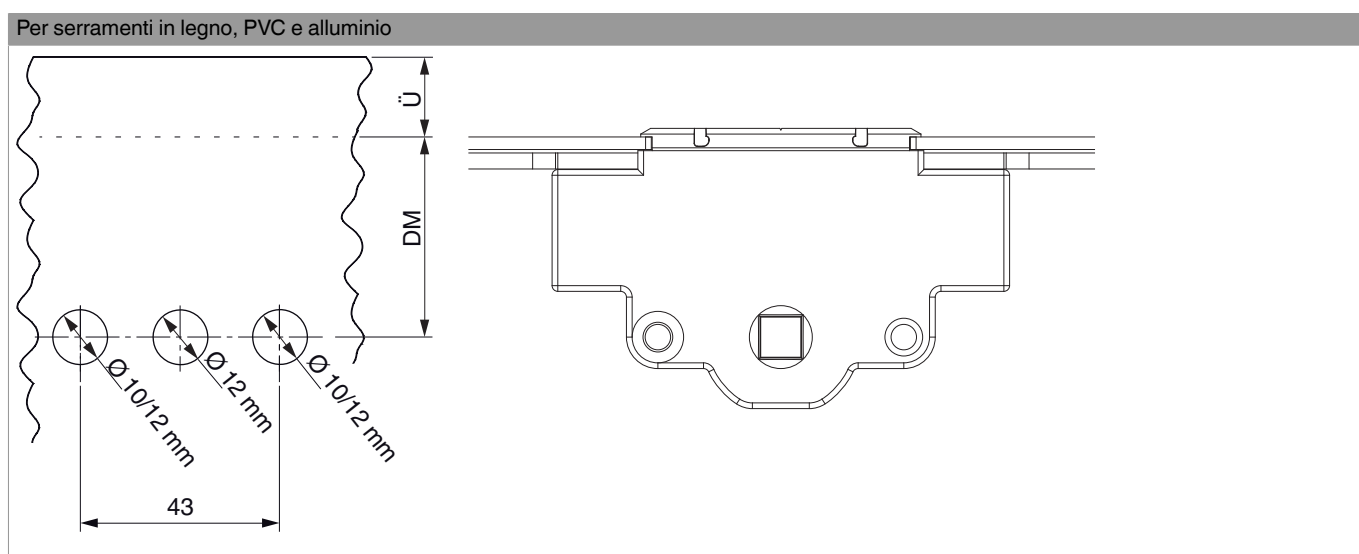

Schema foro per scatola serratura

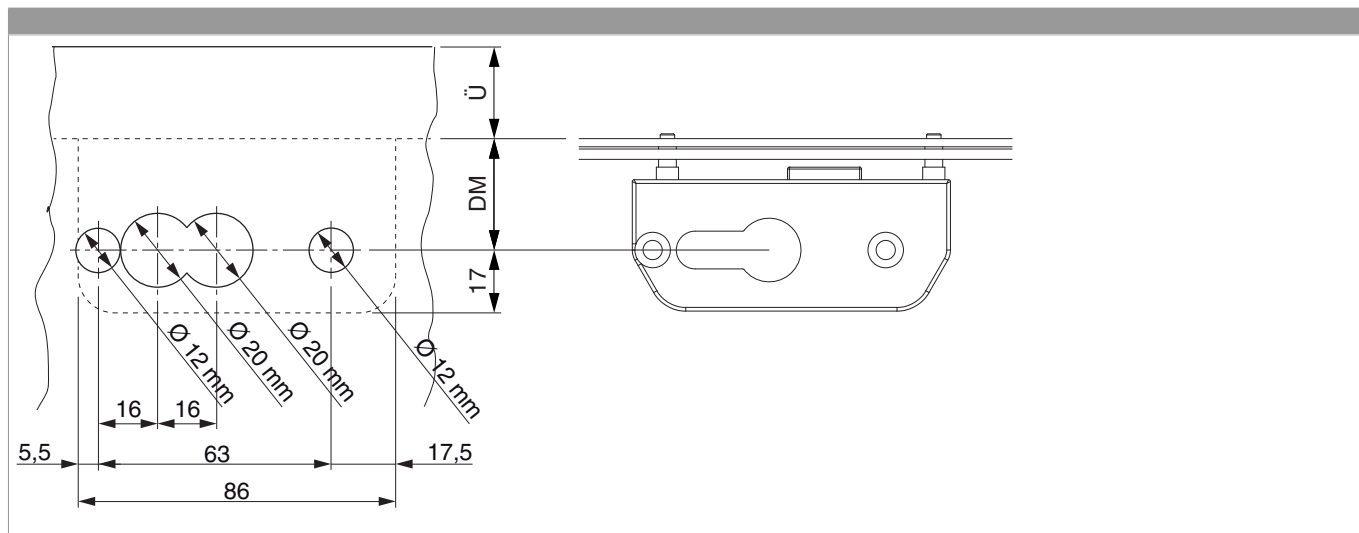

Schema di tranciatura

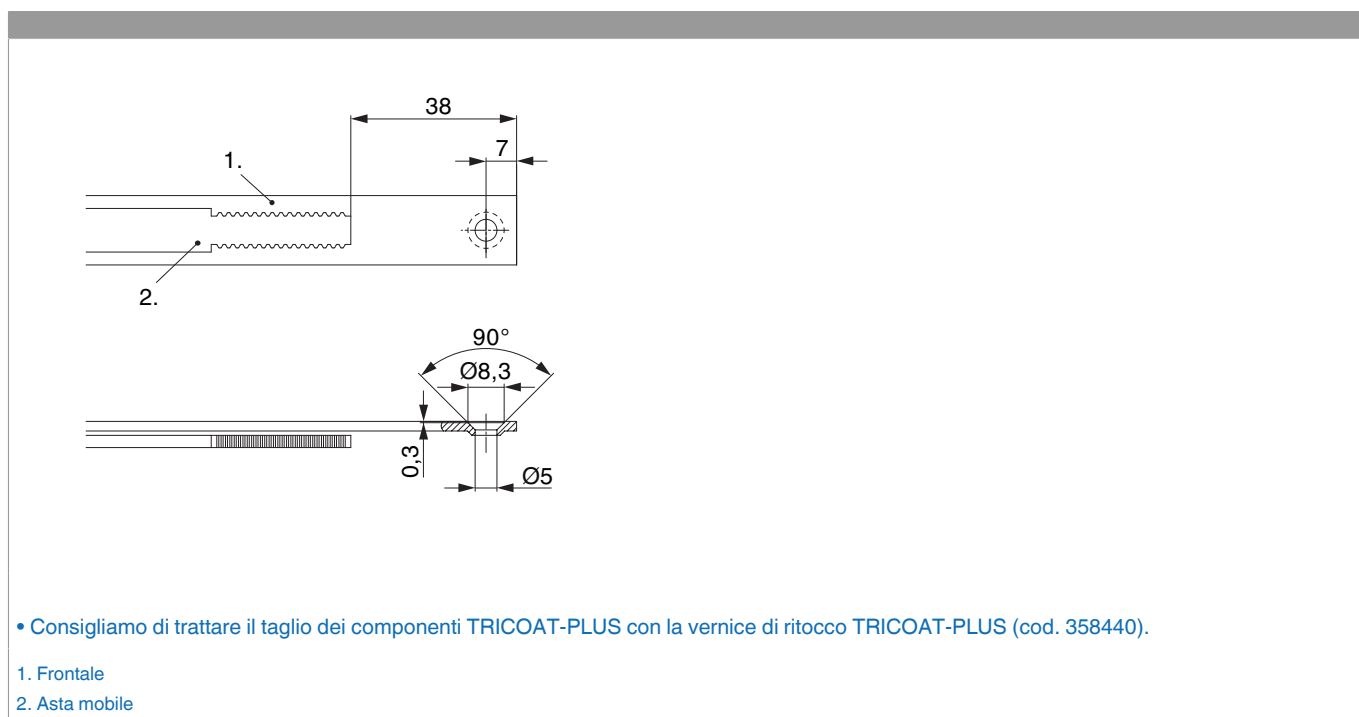

Posizionamento scontri alza anta

Scontro alza-anta A4 / senza scrocco porta

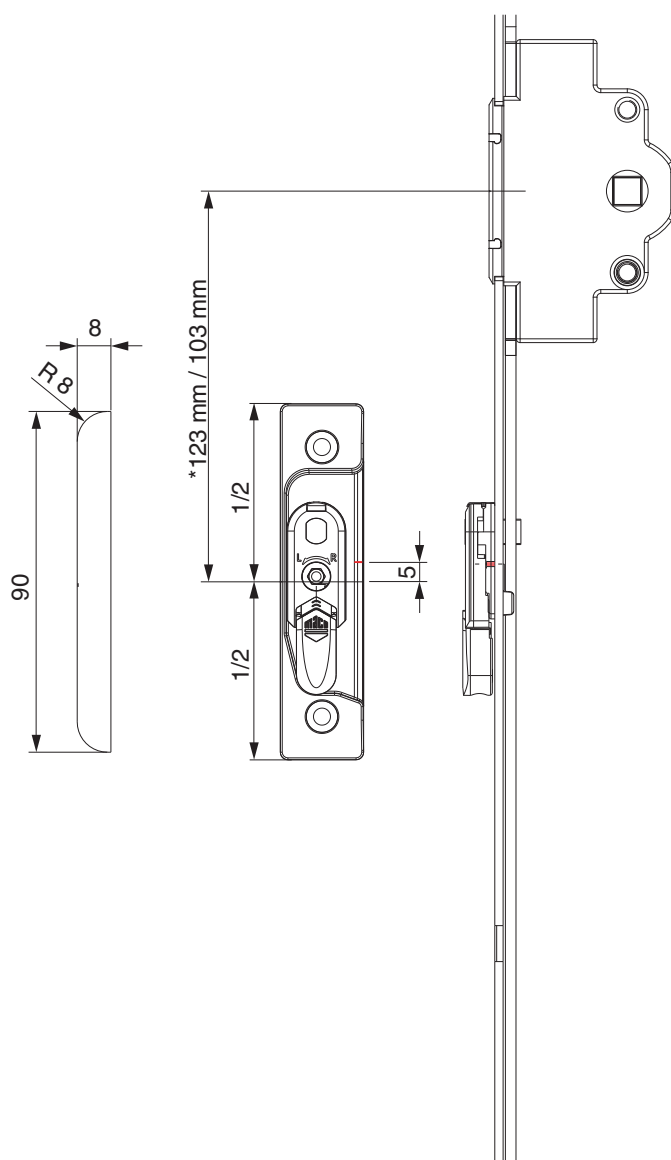

* con cremonesi grandezza 660

A12

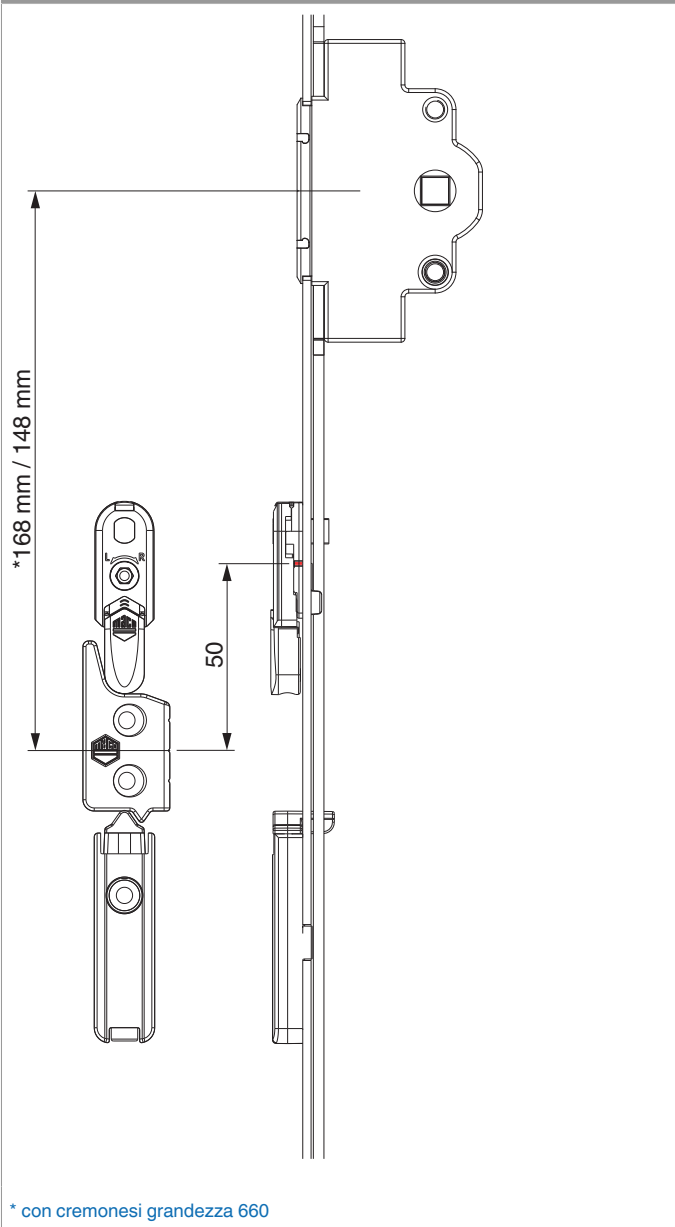

Oscillazione e regolazione in altezza dell'alza anta

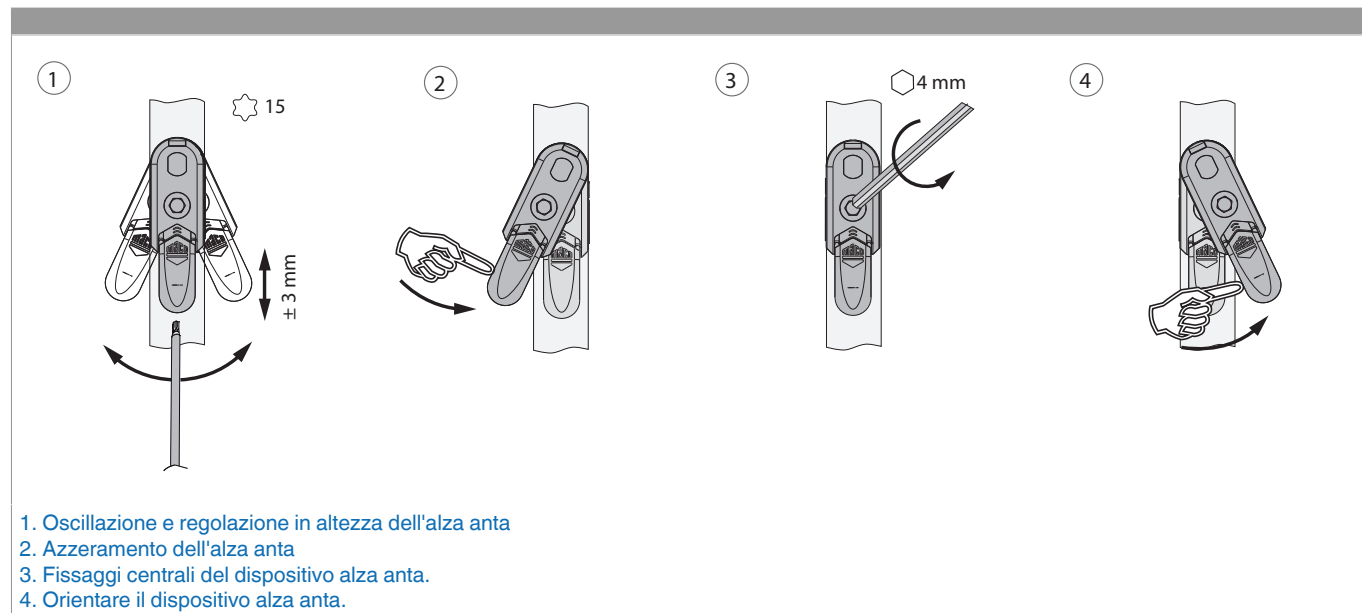

Collegamento a clips

Agganciare collegamenta a clips

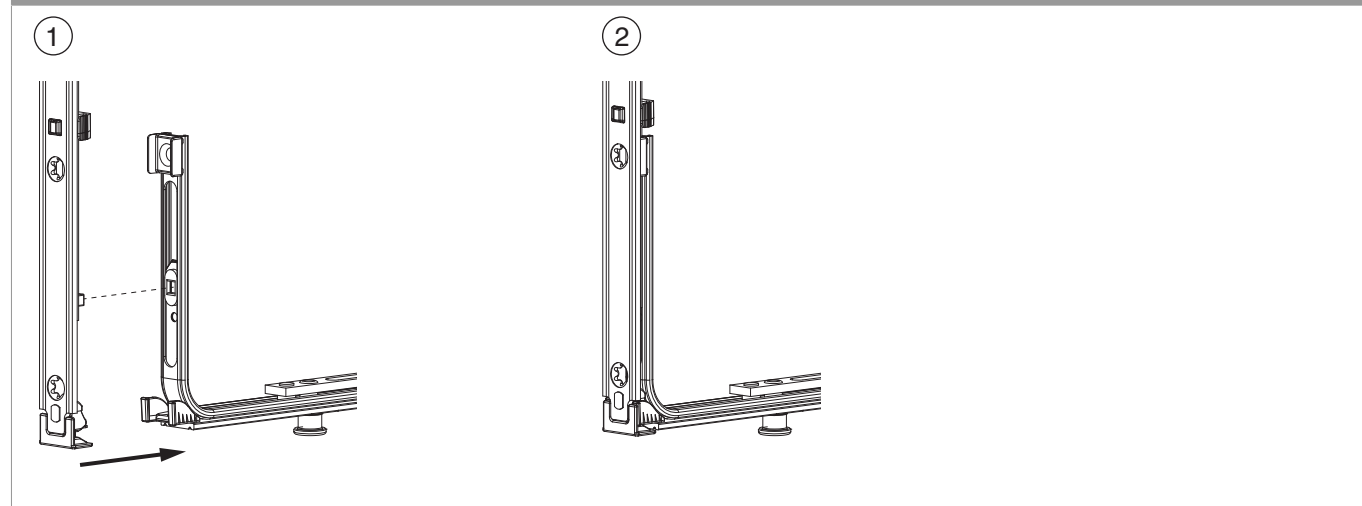

Sganciare collegamento clips

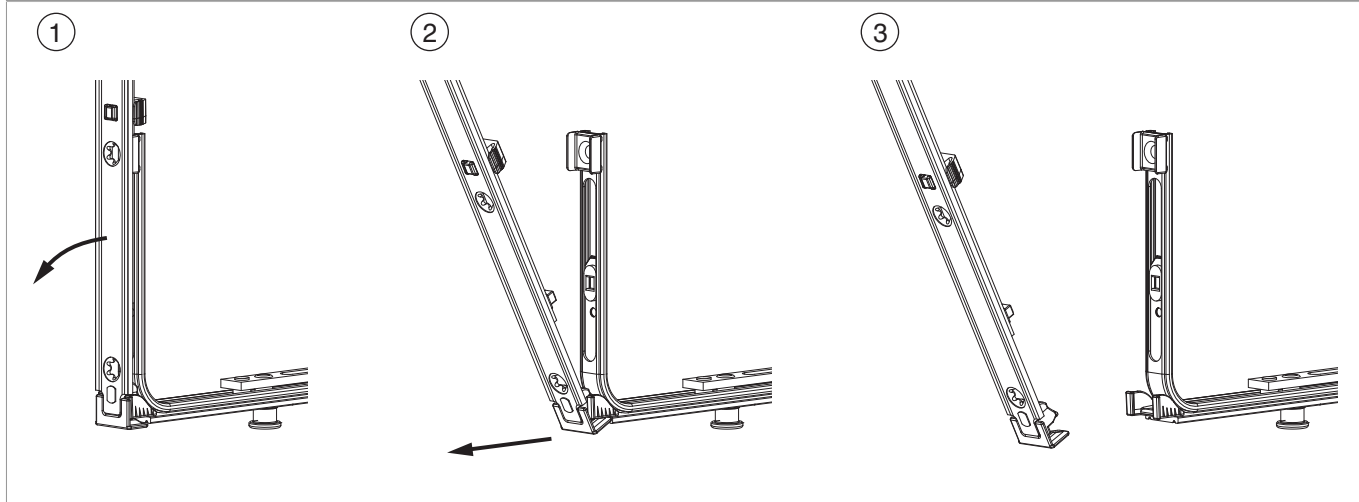

Collegamento scarpetta dentata

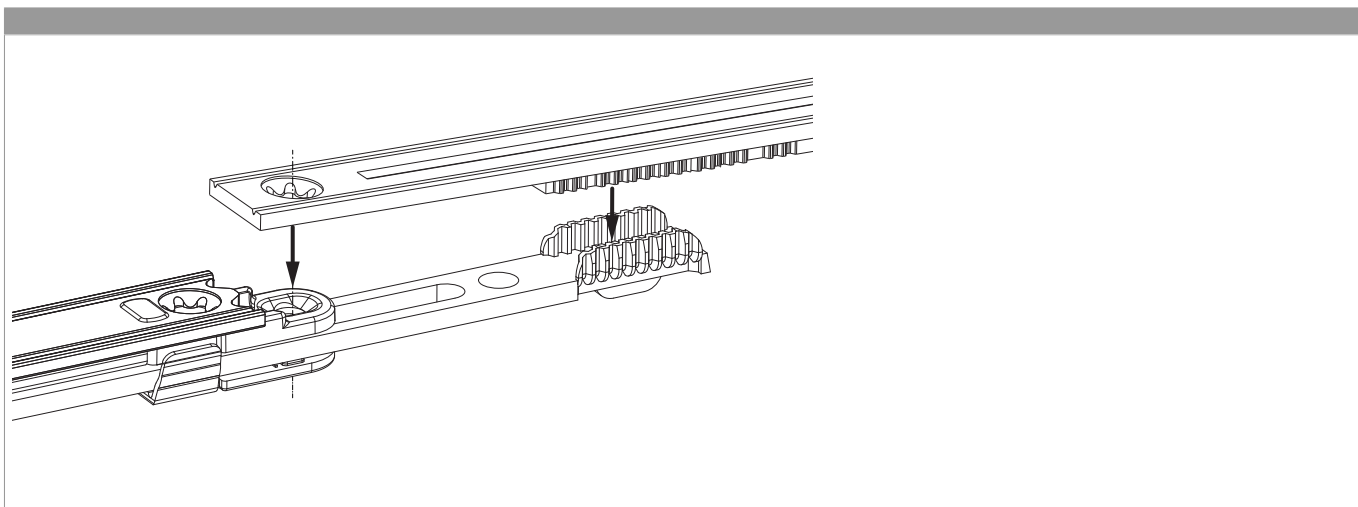

Cremonese con serratura - preparazione della finestra

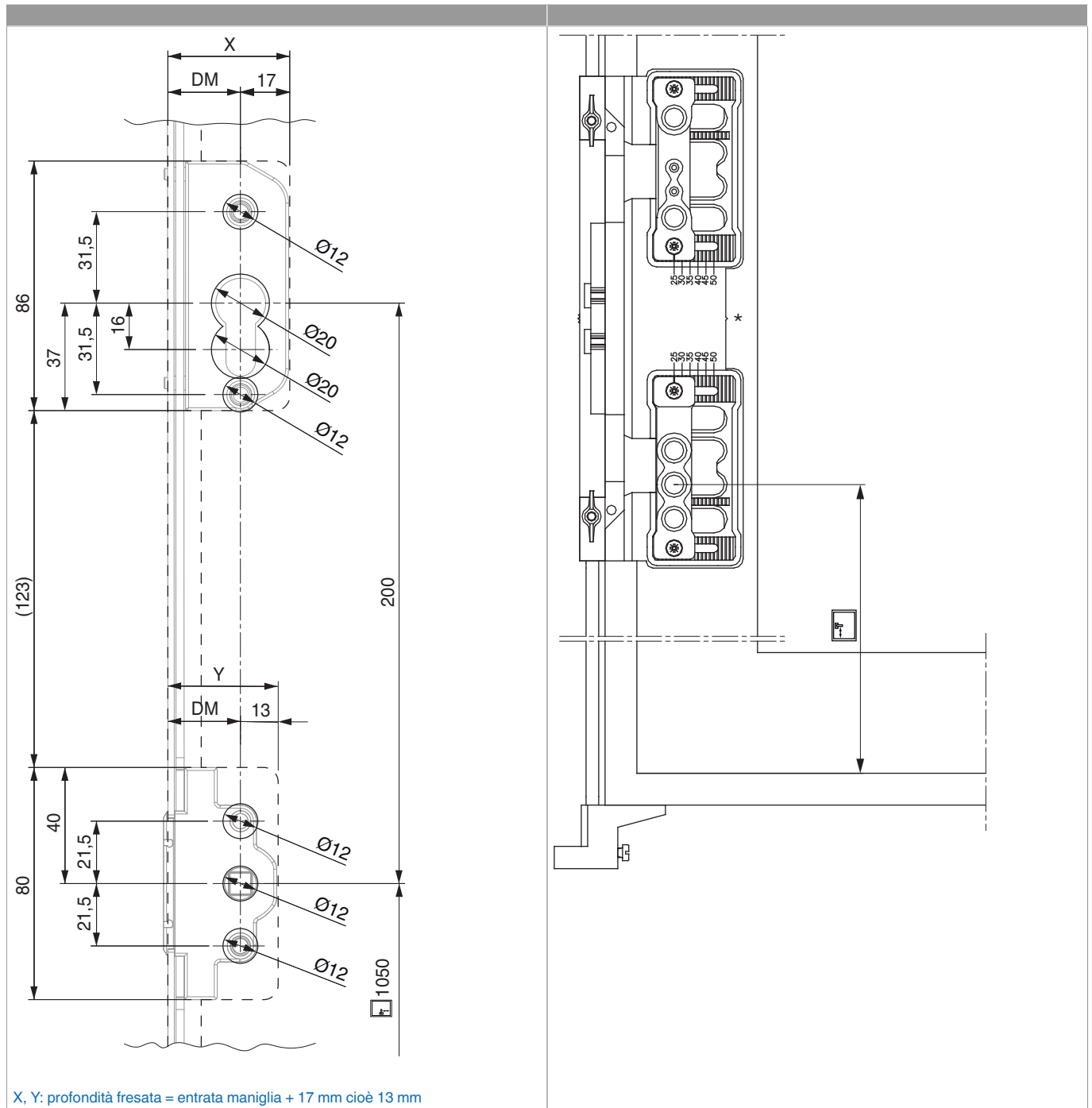

Regolazione pressione

Fungo e nottolino

