

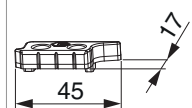



356775 - Scontro alza anta MultiMatic per canalino euro 7/8x4 con vite inclinata sinistro argento

Disegni tecnici



				L	B	H		Nº
argento	Scontro alza anta MultiMatic per canalino euro 7/8x4	con vite inclinata	sinistro	45	17	6	100	356775

Sezioni profilo

A12 Euronut 7/8/4 - 1 anta

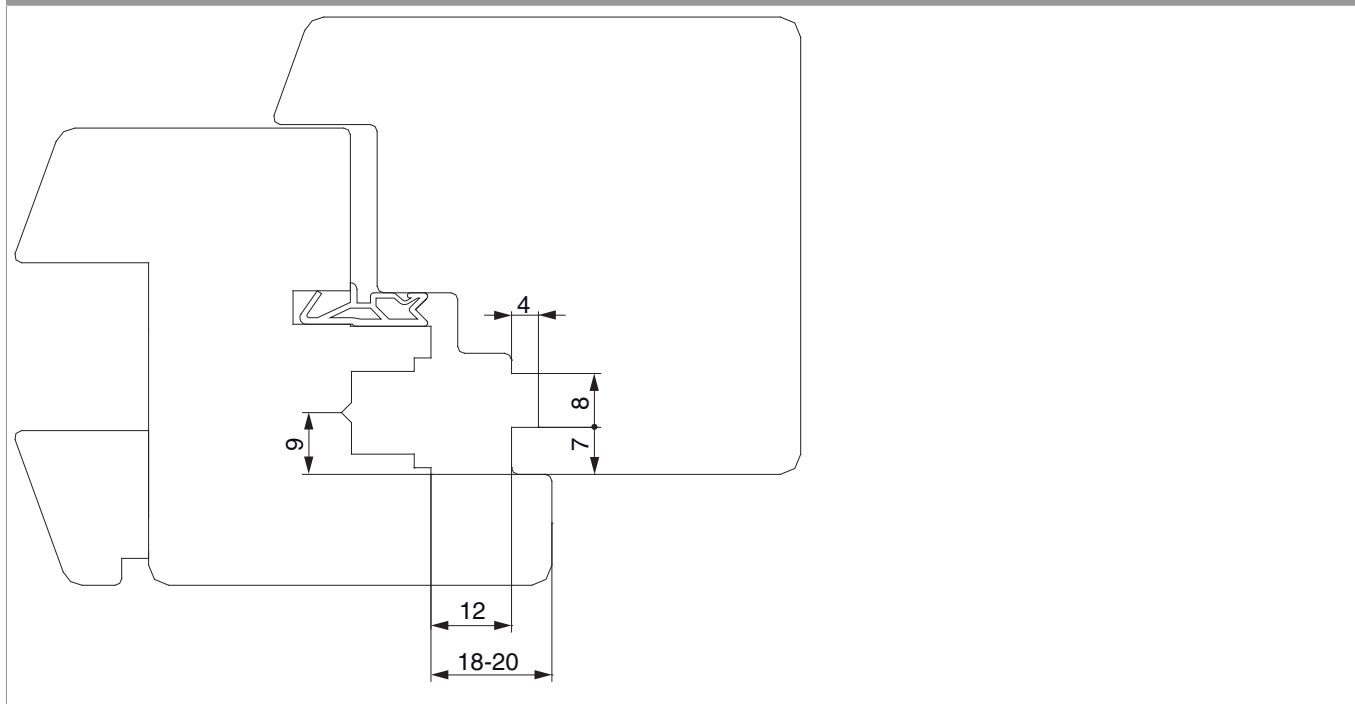

A12 Euronut 7/8/4 - 2 ante

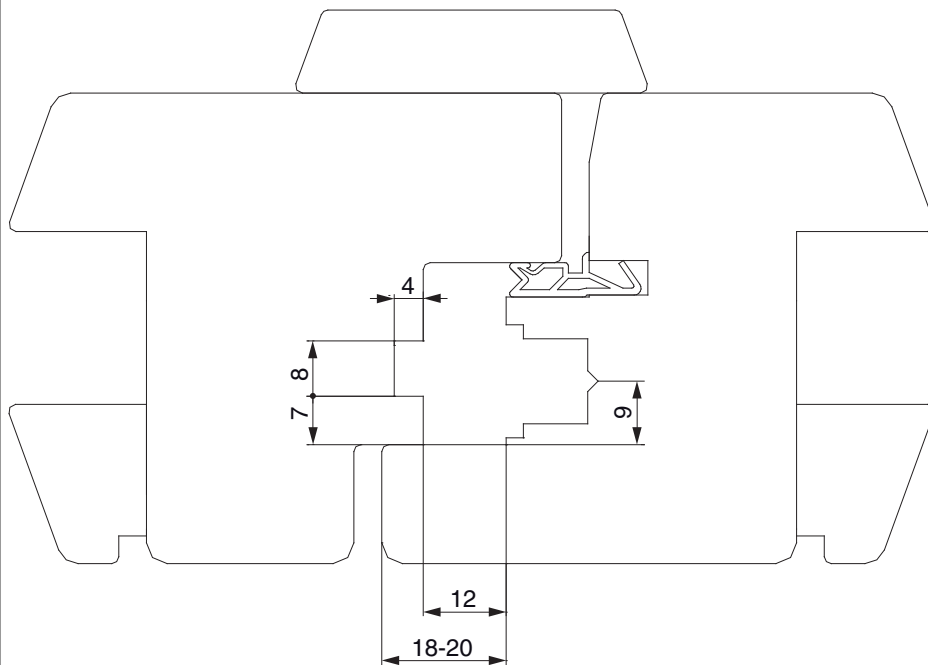

Costruzione alternativa della finestra 1 anta

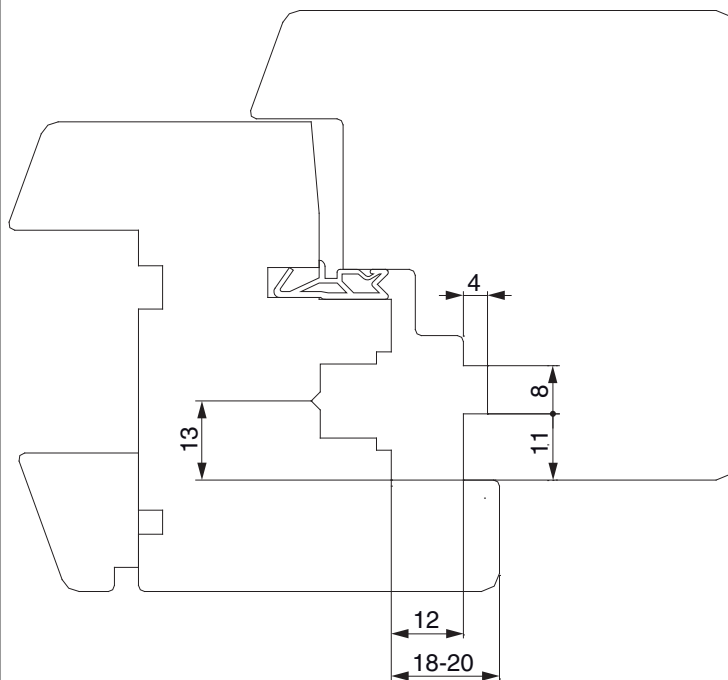



Costruzione alternativa della finestra 2 ante

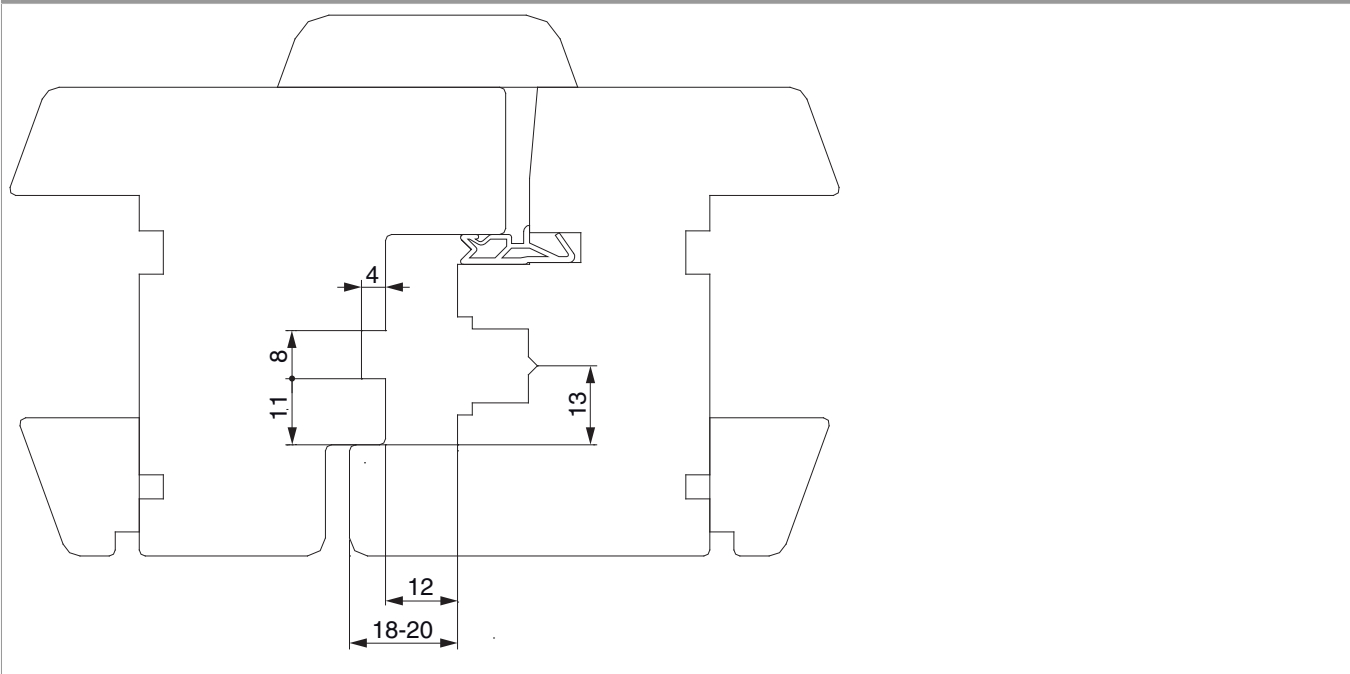

Posizionamento scontri alza anta

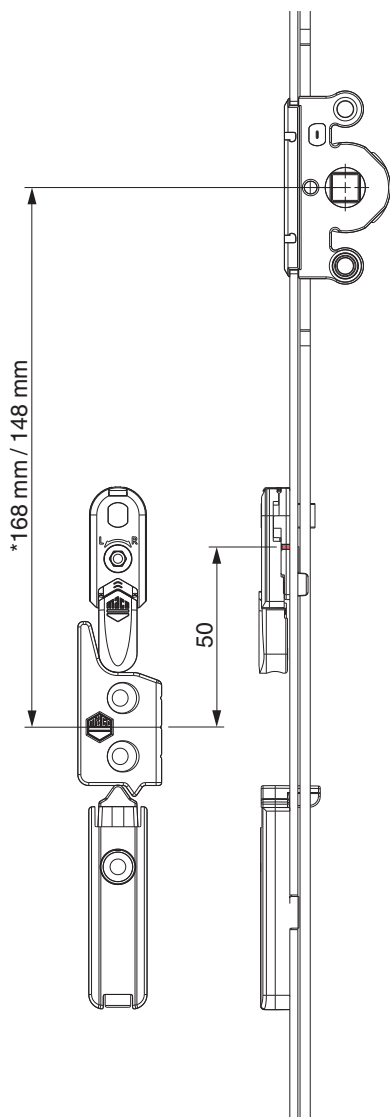

* con cremonesi grandezza 660