

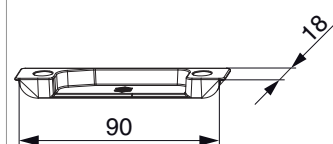

356504 - Scontro alza anta MultiMatic per A4 scost. 9 mm destro argento

Disegni tecnici



				L	B	H		Nº
argento	Scontro alza anta MultiMatic per A4 scost. 9 mm		destro	90	18	8	100	356504 ¹⁾

¹⁾ Su elemento destro usare scontro sinistro e viceversa

Sezioni profilo

A4 scost.9 - 1 anta

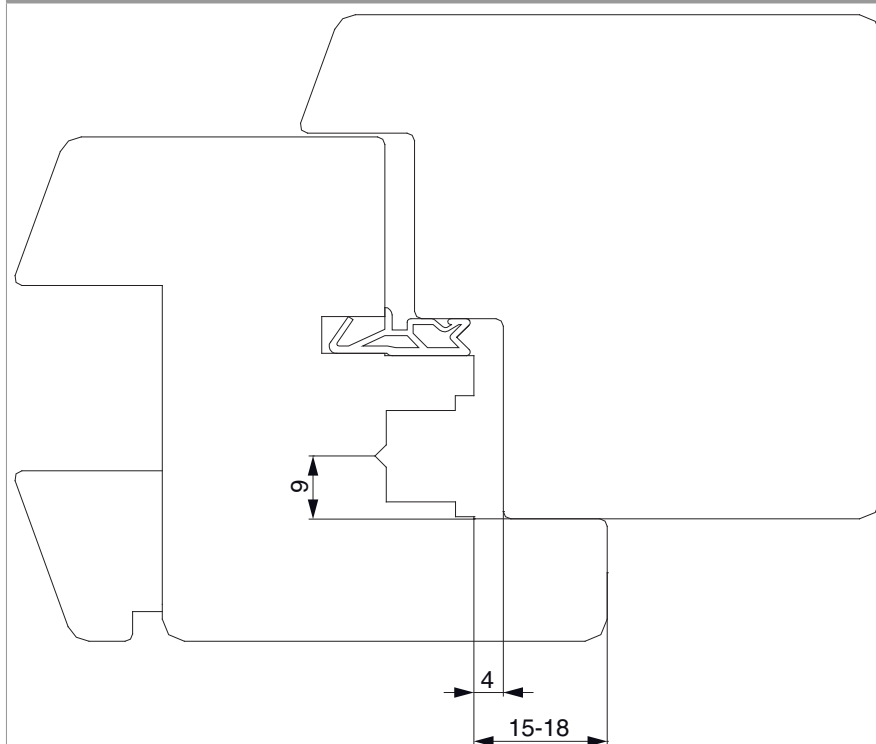



A4 scost.9 - 2 ante

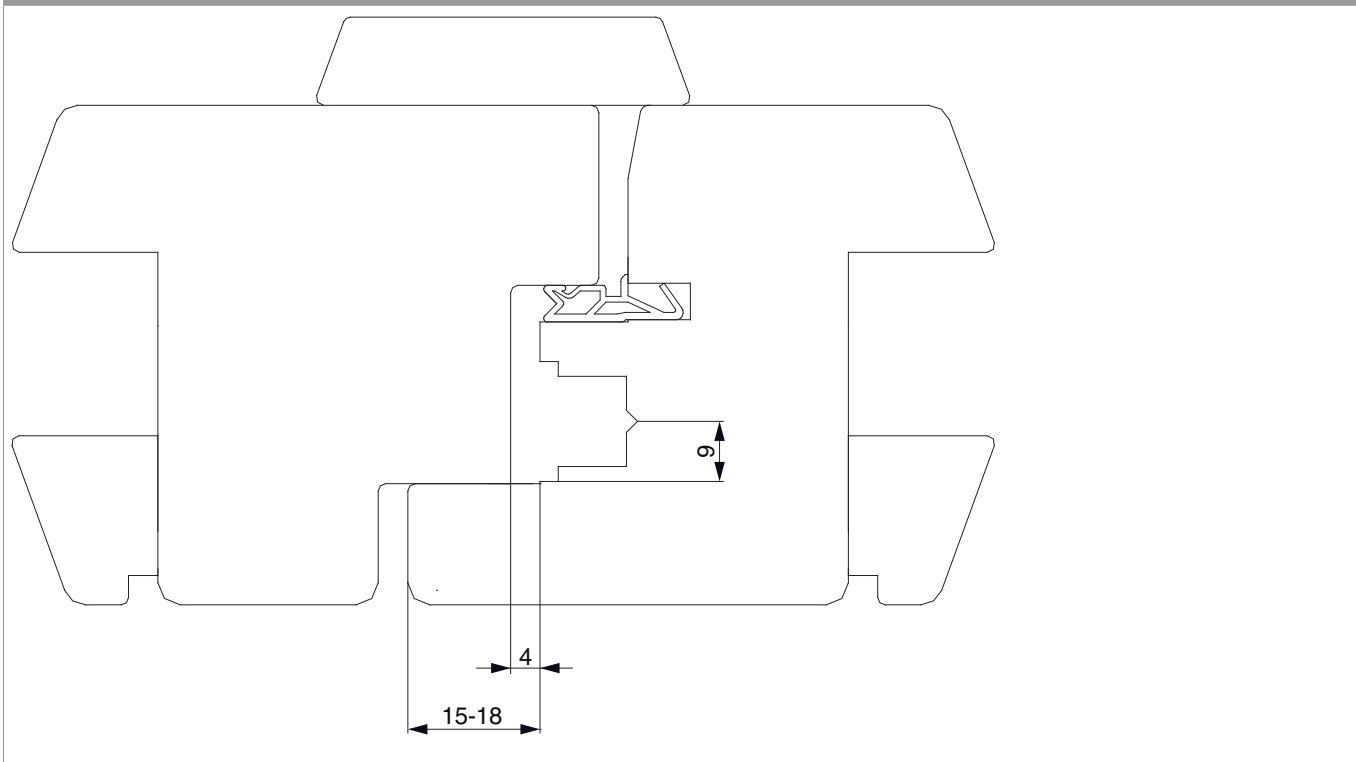

Posizionamento degli scontri

Scontro alza-anta A4 / senza scrocco porta

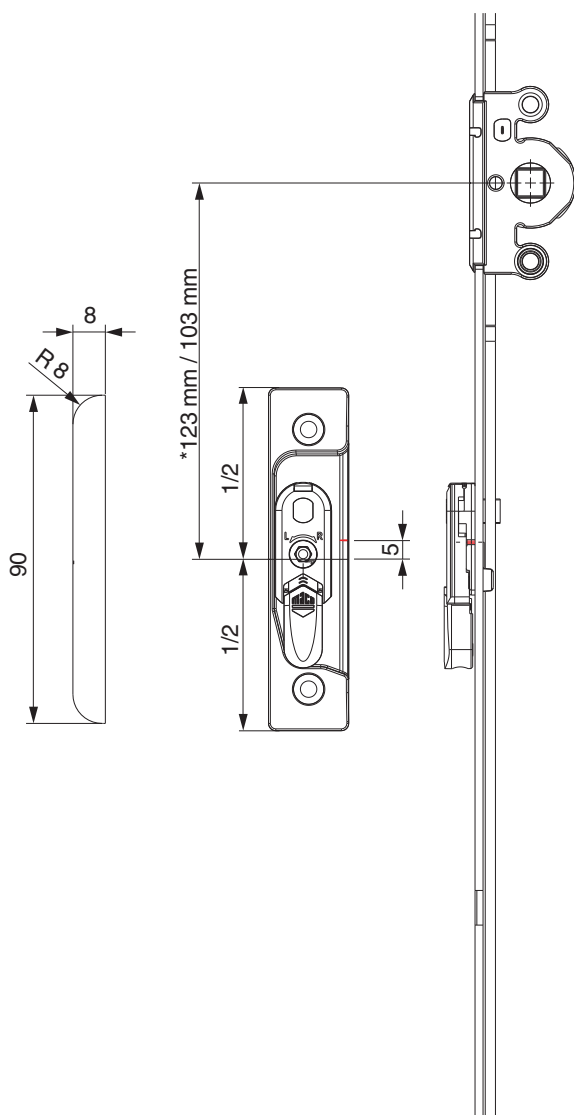

* con cremonesi grandezza 660

Fresata

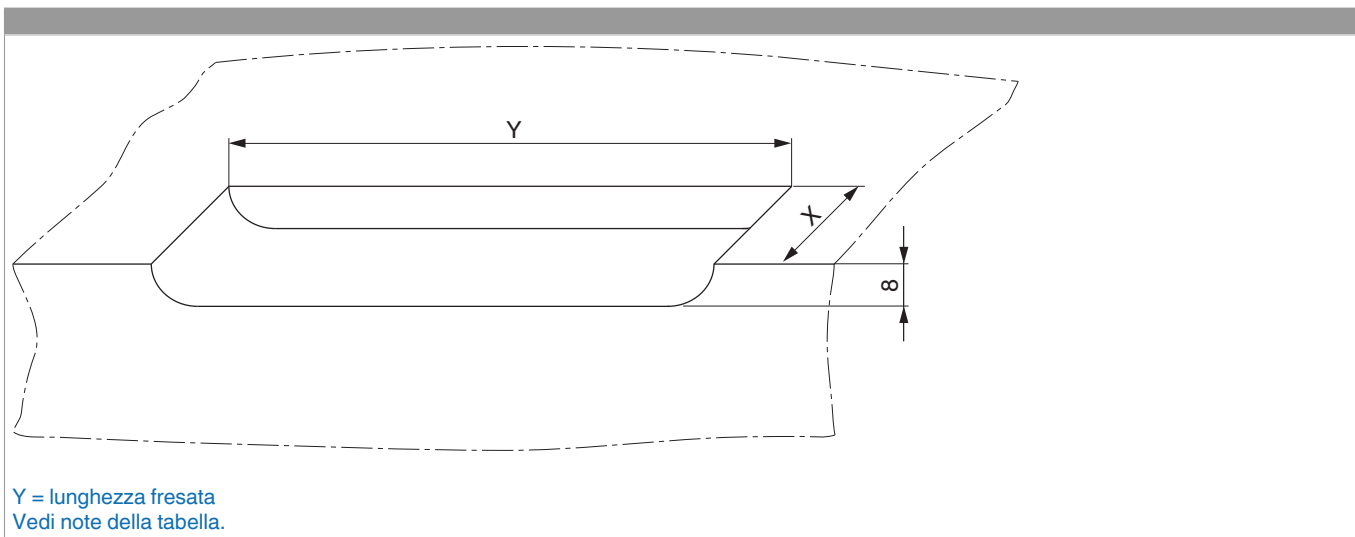

Y = lunghezza fresata
Vedi note della tabella.

Scostamento	X
scostamento 9 mm	18 mm
scost.13	22 mm