

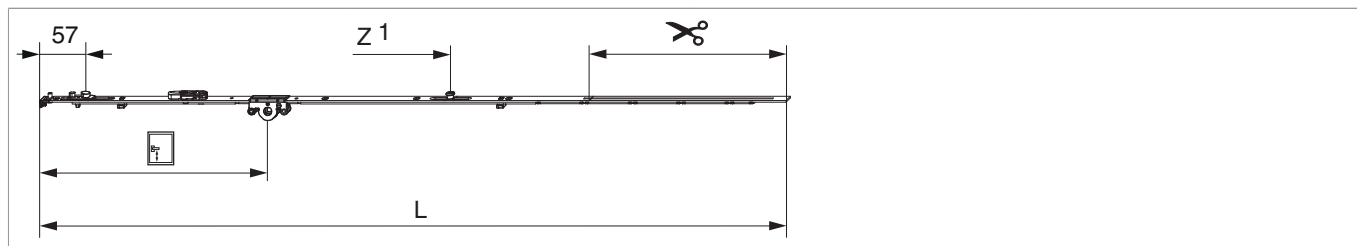

209378 - Cremonese Multi Matic 1590 E15 fix con bilanciere con 1 fungo HBB 1.341-1.590 HM500 argento

Disegni tecnici



		L							Nº
argento	1590	1.486,5	15	500	1.341 - 1.590	260,5	1	10	209378

Tabella posizionamento viti

Nº		1	2	3	4	5	6	7	
209378	7	18,5	91,5	328,5	574	830	920	1.119	

Tabella punti di chiusura

Nº		Z1	
209378	1	875	

Dime

						Nº
Dima fresa per cremonese fix MM con bilanciere			Aria 4	1.341 - 1.700	1	214154
Dima fresa per cremonese fix MM con bilanciere		2 ante	Aria 4	1.341 - 1.700	1	214158
Dima forature per fori martellina MM		per punta 3mm			1	203861
Dima forature per fori martellina MM		per punta D=3 mm e D=12 mm			1	203862
Dima completa con guida-scontro per cremonese fix MM	con guidascontro L=48mm			1.341 - 1.700	1	204775
Dima completa con guida-scontro per cremonese fix MM	scontri 48 mm	2 ante	per cava ferramenta	1.341 - 1.700	1	210984

Quote della scatola cremonese



- Larghezza fresata per scatola cremonese 12 mm
- Per fissaggio maniglia utilizzare viti SPAX Ø 5 mm o viti M5.

Schema di fresata

per PVC e alluminio

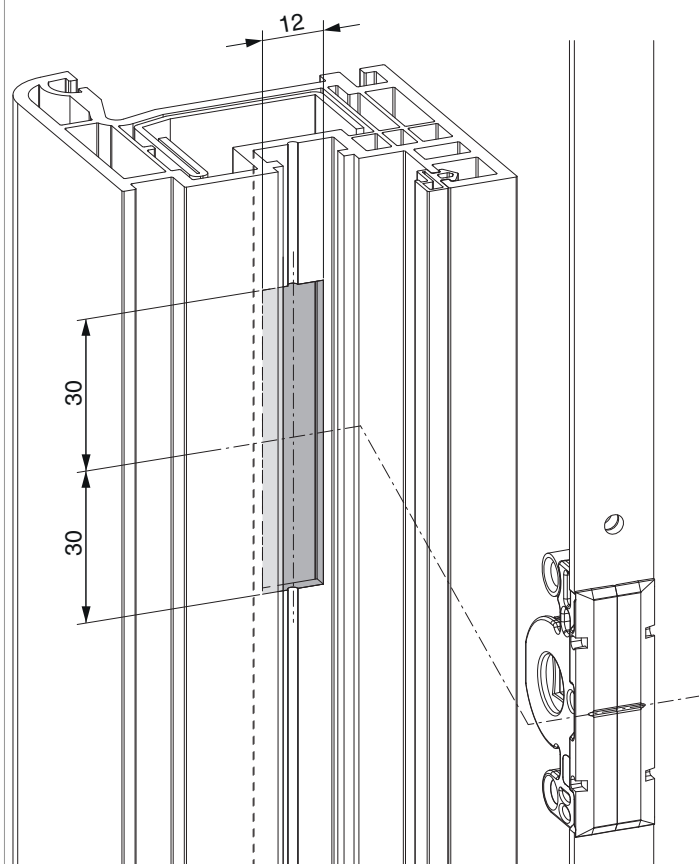

Schema di foratura

Per serramenti in legno

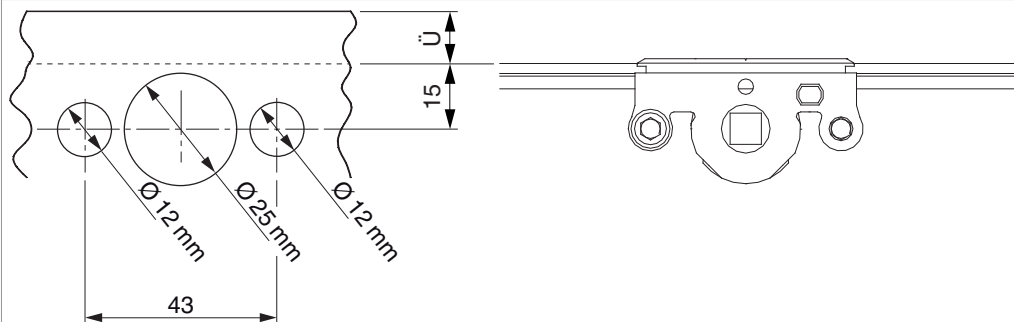

Per serramenti in PVC e alluminio

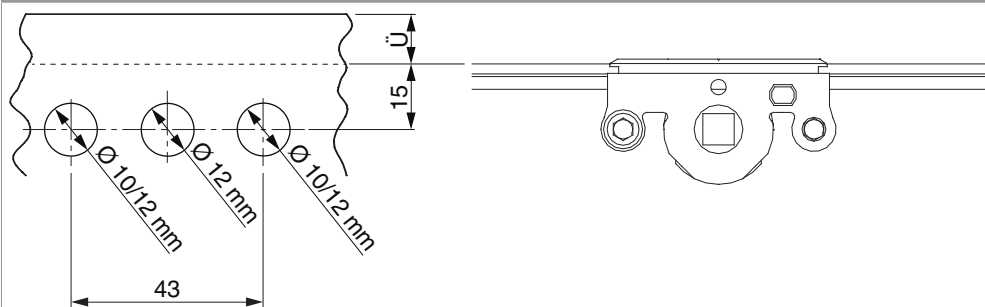

Schema di tranciatura

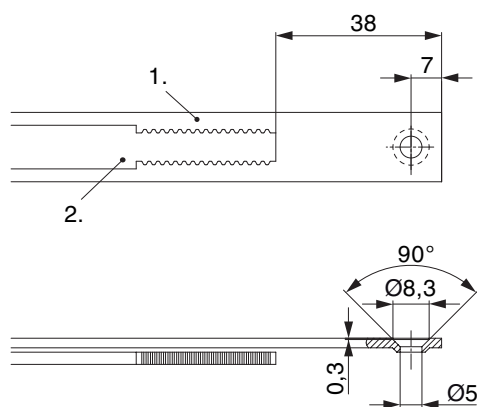

• Consigliamo di trattare il taglio dei componenti TRICOAT-PLUS con la vernice di ritocco TRICOAT-PLUS (cod. 358440).

1. Frontale
2. Asta mobile

Posizionamento scontri alza anta

Scontro alza-anta A4 / senza scrocco porta

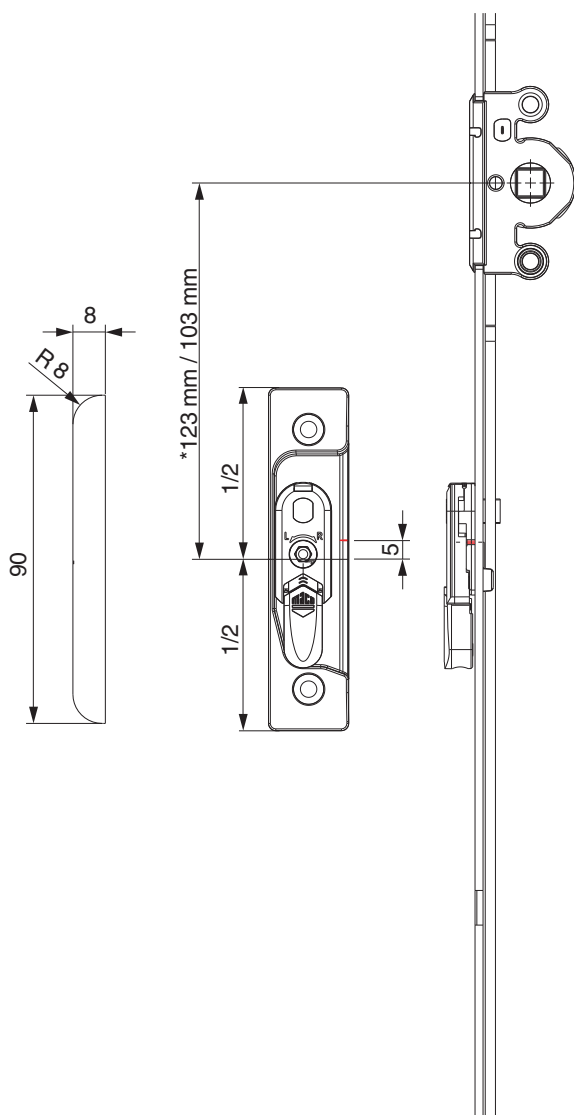

* con cremonesi grandezza 660

A12

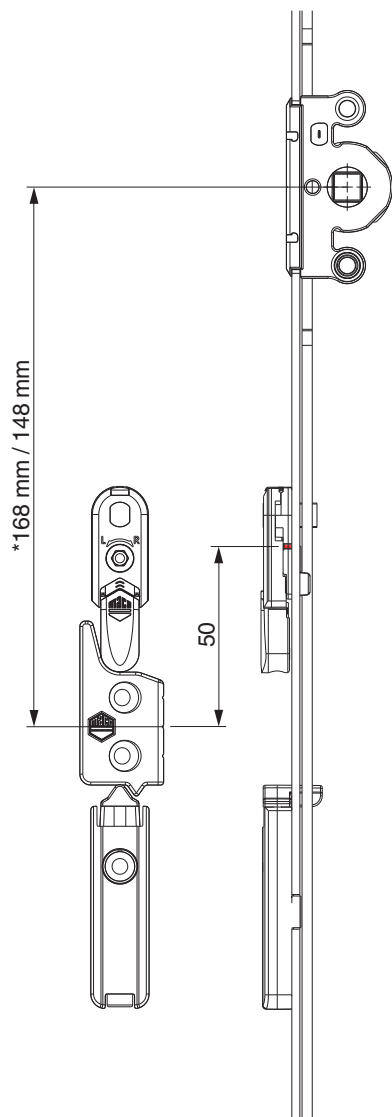

* con cremonesi grandezza 660

Oscillazione e regolazione in altezza dell'alza anta

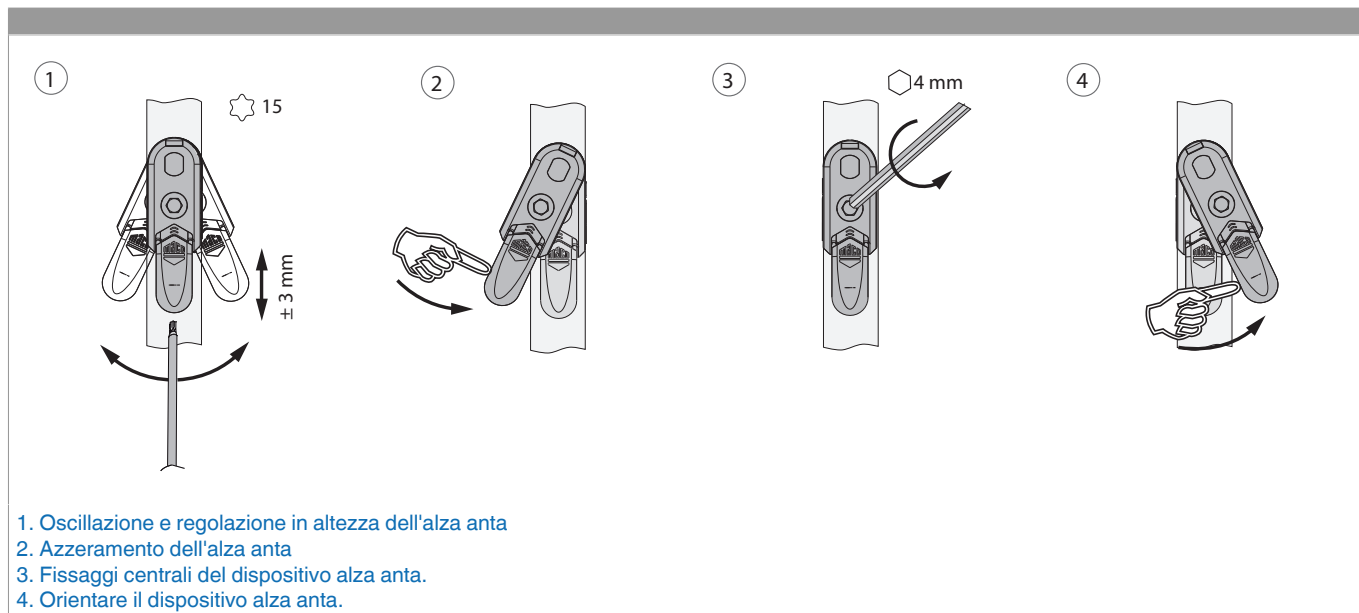

Collegamento a clips per bilanciere

Agganciare collegamenta a clips

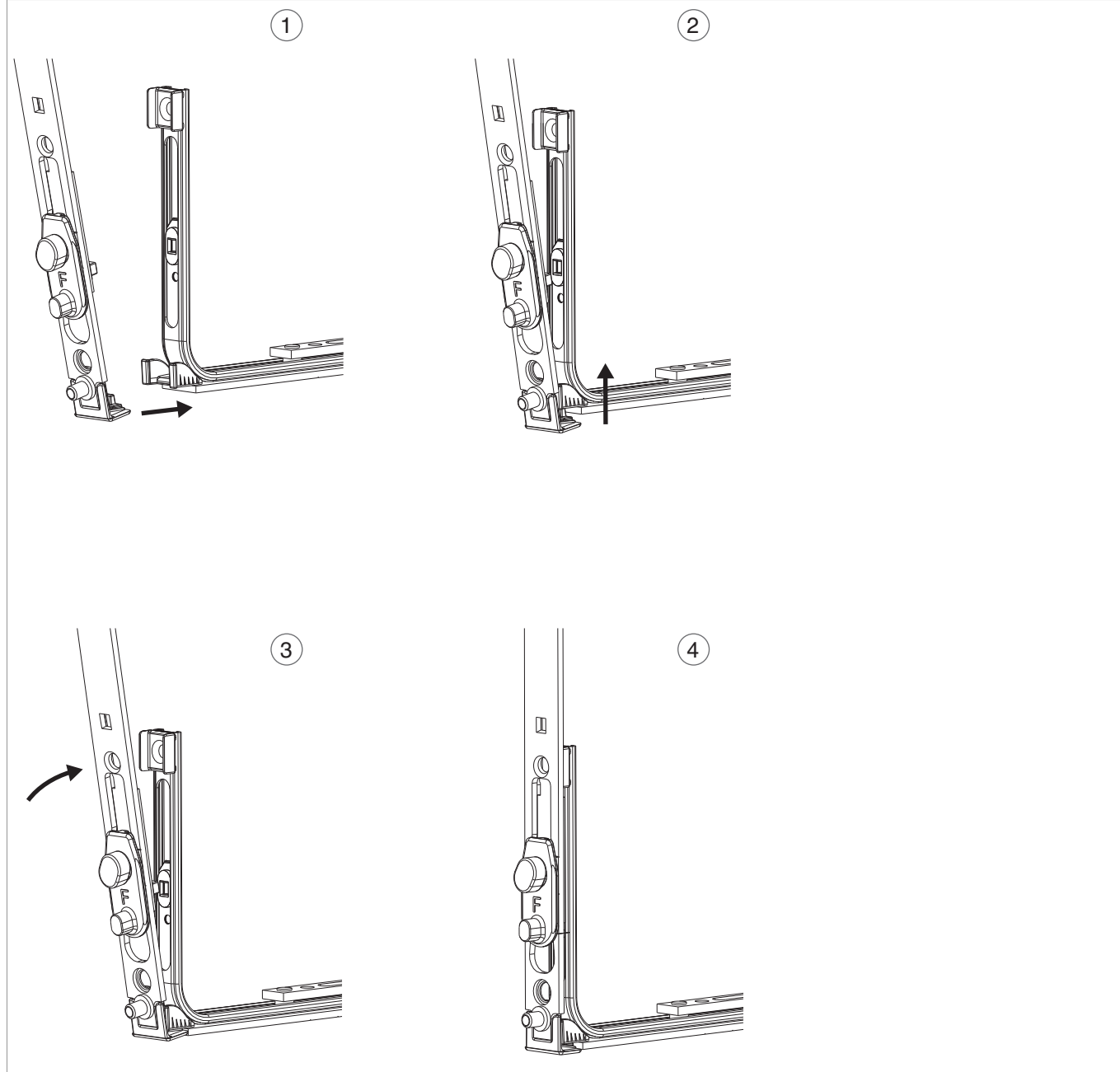

Collegamento scarpetta dentata

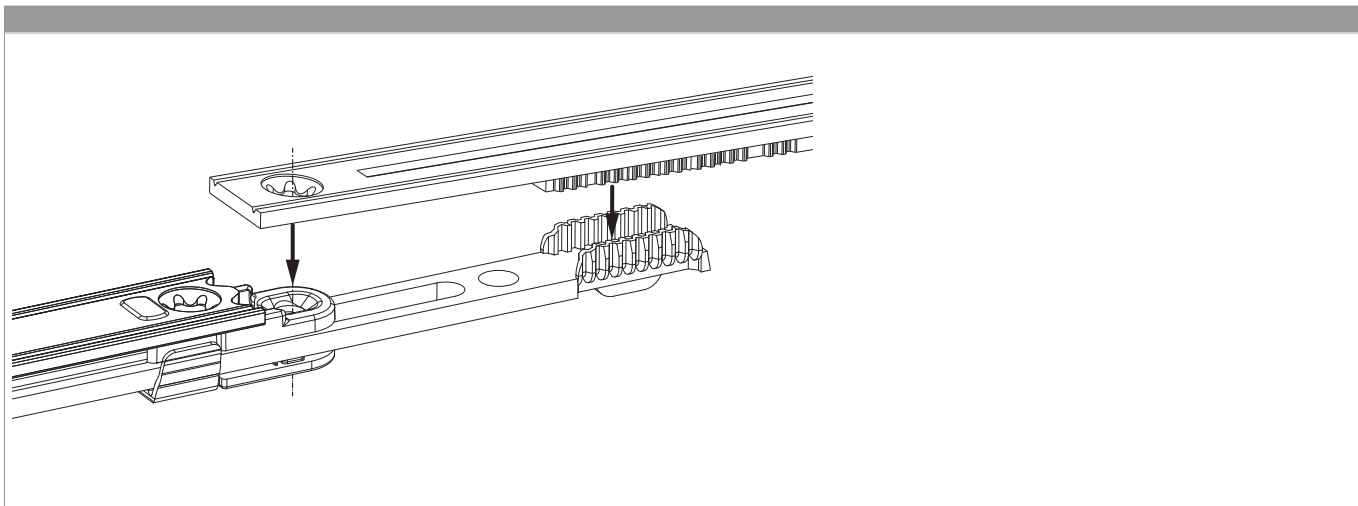

Posizione nottolino al bilanciere

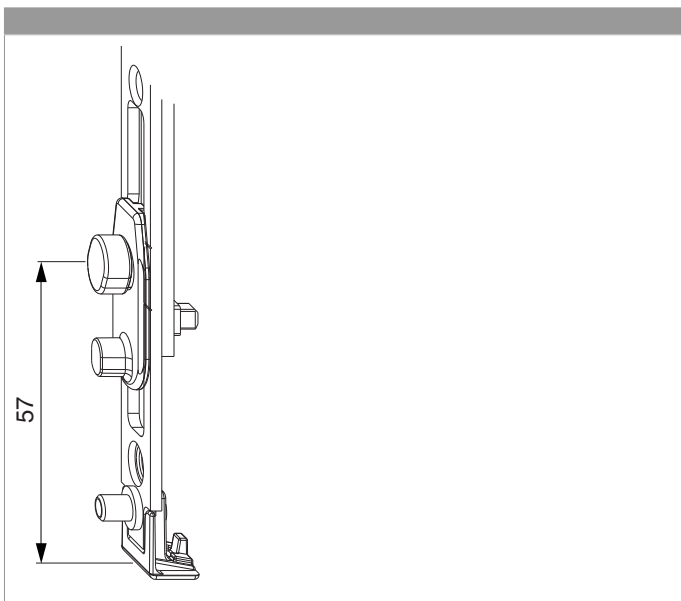

Regolazione in pressione su bilanciere

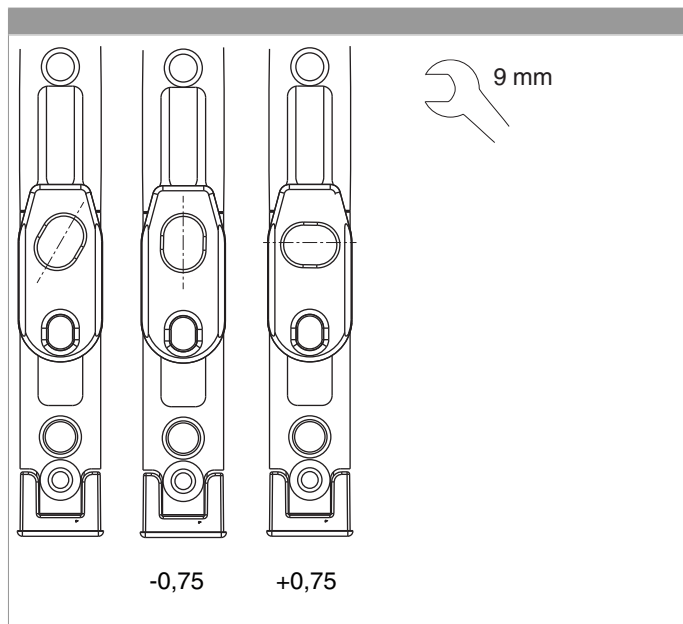

Regolazione pressione

