

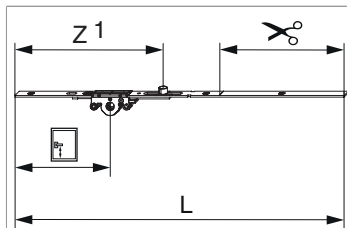

211961 - Asta rulli fix Multi Matic 430 E15 con 1 nottolino HBB 270-430 HM125 argento

Disegni tecnici









		L						Nº
argento	430	435	15	125	270 - 430	165	20	211961

Tabella posizionamento viti



Nº		1	2	3	4	5	6	7	8	9	10	11	12	13	14	15	16
211961	3	18,5	250	350													

Tabella punti di chiusura

Nº		Z1	Z2	Z3	Z4	
211961	1	193				

Dime

			Nº
Dima forature per fori martellina MM	per punta 3mm	1	203861
Dima forature per fori martellina MM	per punta D=3 mm e D=12 mm	1	203862

Quote della scatola cremonese

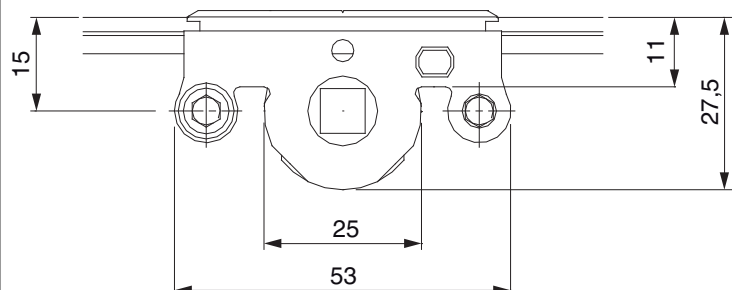

- Larghezza fresata per scatola cremonese 12 mm
- Per fissaggio maniglia utilizzare viti SPAX Ø 5 mm o viti M5.

Schema di foratura

Per serramenti in legno

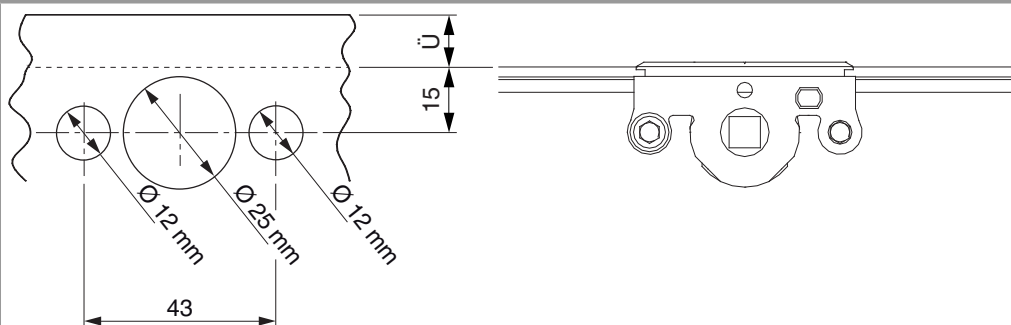

Per serramenti in PVC e alluminio

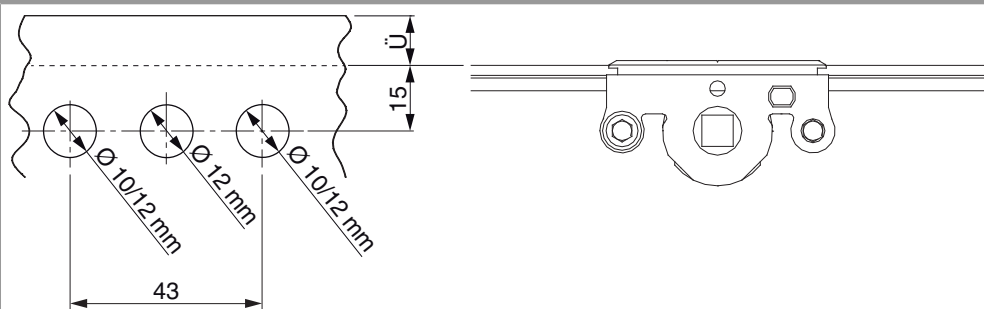

Regolazione pressione

Fungo e nottolino

