

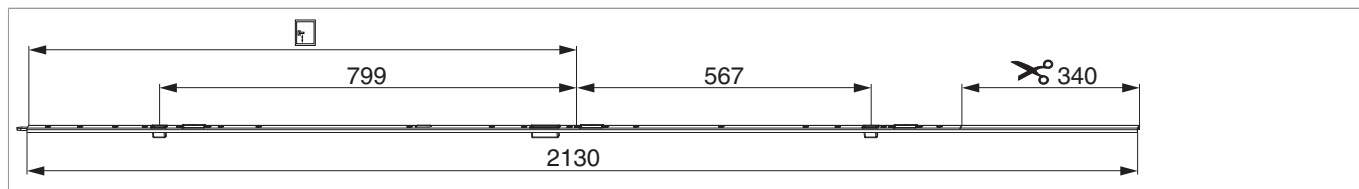







219426 - Asta a leva per serratura 2 scrocchi-punzoni K+605 HM1.050 sinistro argento U-8/24/8

Disegni tecnici



							L			Nº
argento	sinistro	2 scrocchi-punzoni K+605	1.050	8	24	8	2.130	340	5	219426 ¹⁾

¹⁾ Viene utilizzato con serratura automatica comando cilindro Z-TF

Tabella posizionamento viti

Nº		1	2	3	4	5	6	7	8	9	10	11	12	13	14	15	16	17
219426	16	-1.012	-950	-883	-826	-680	-608	-318	-160	-98	-11	117	280	442	504	592	699	

Posizionamento dell'asta a leva

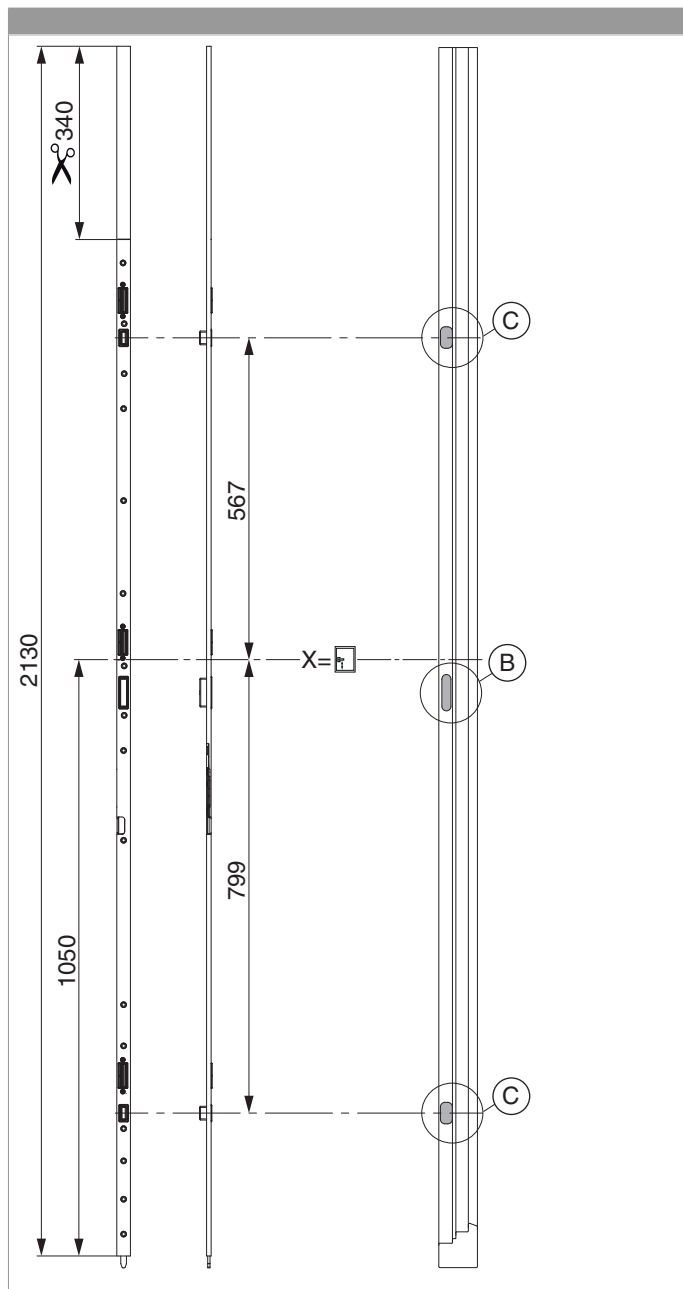

Schema foro e fresata

Dettaglio B

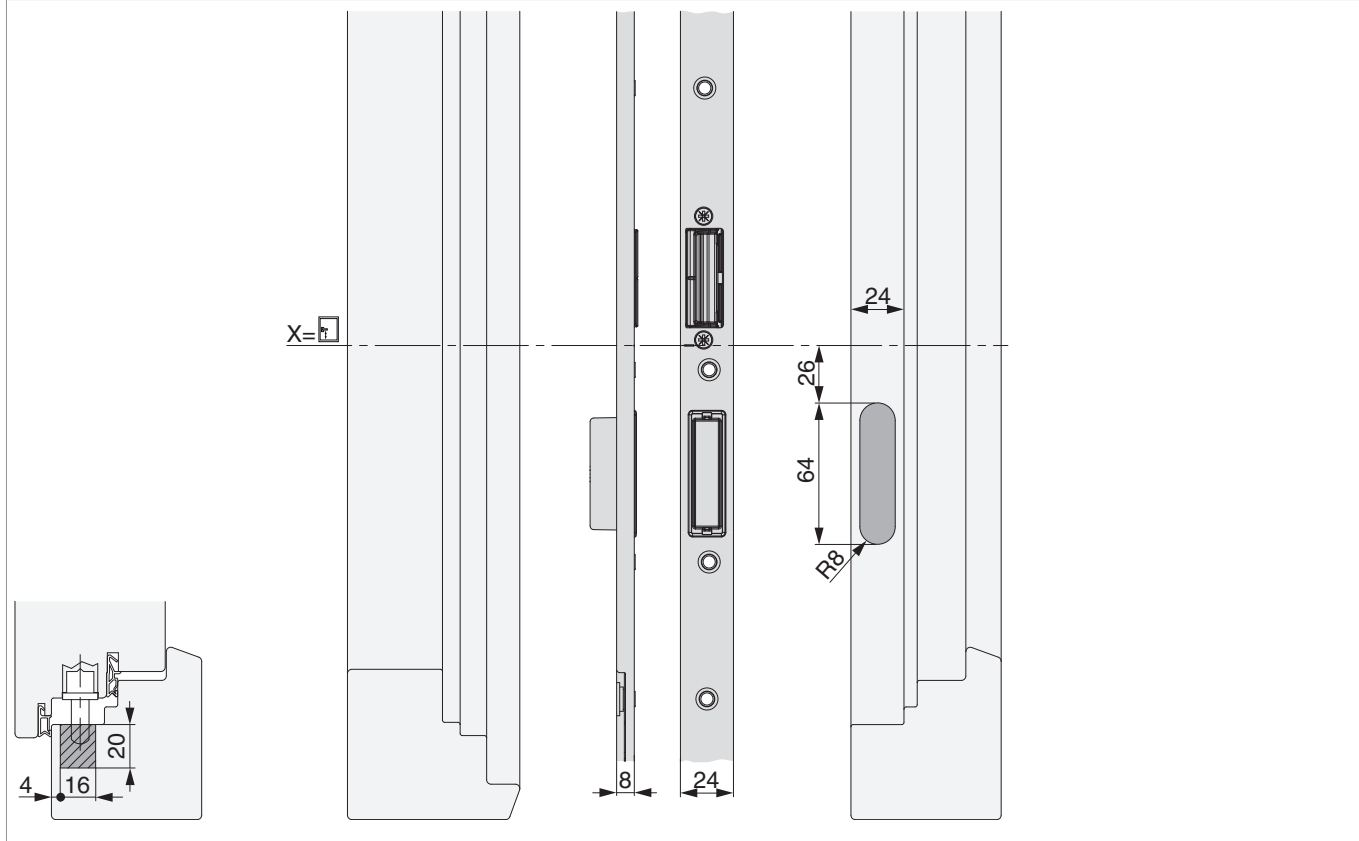

Dettaglio C

