

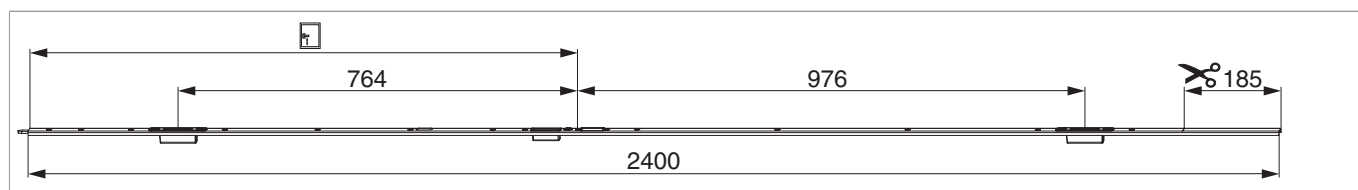







219802 - Asta a leva per serratura 2 scrocci-ganci K+980 HM1.050 destro argento PB 24 mm scost. 13 mm U-8/24/8

Disegni tecnici



							L			Nº
argento	destro	2 scrocci-ganci K+980	1.050	8	24	8	2.400	185	5	219802 ¹⁾

¹⁾ Viene utilizzato con serratura autobloccante A-TS

Tabella posizionamento viti

Nº		1	2	3	4	5	6	7	8	9	10	11	12	13	14	15	16	17
219802	13	-1.012	-950	-854	-674	-496	-318	-160	-98	117	386	636	886	1.066				



Posizionamento dell'asta a leva

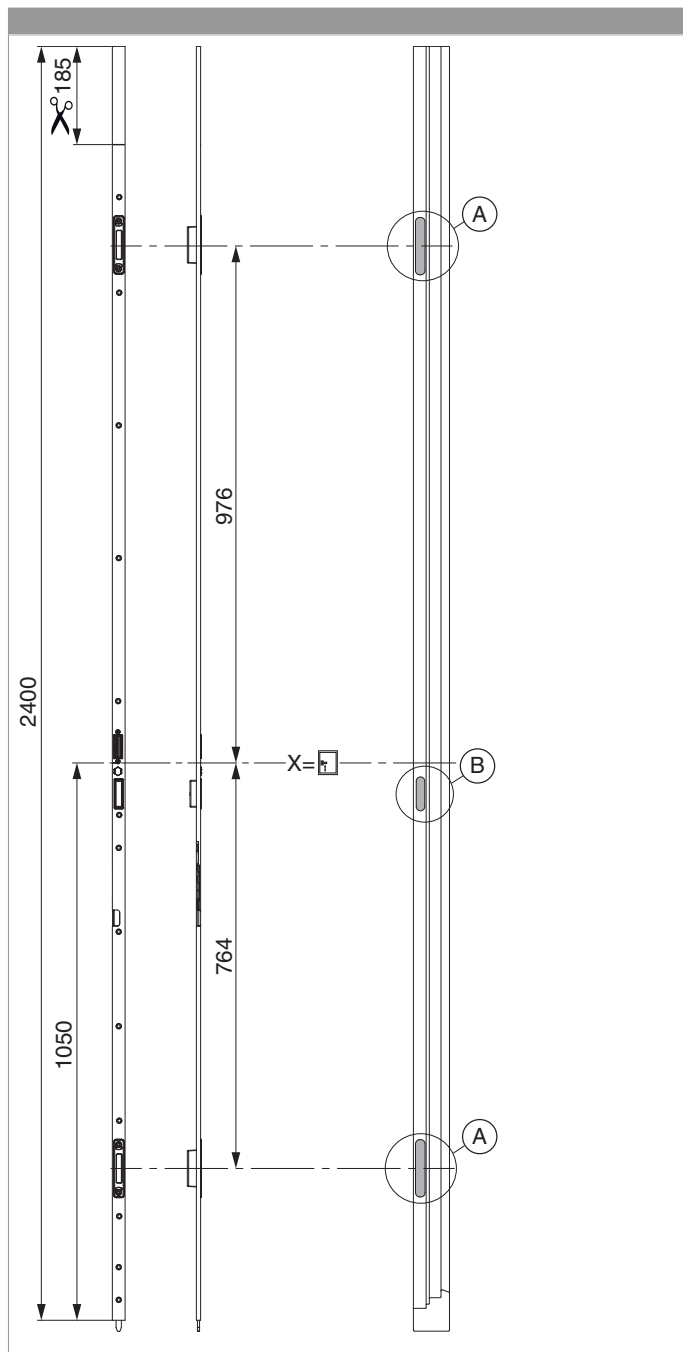



Schema foro e fresata

Dettaglio A

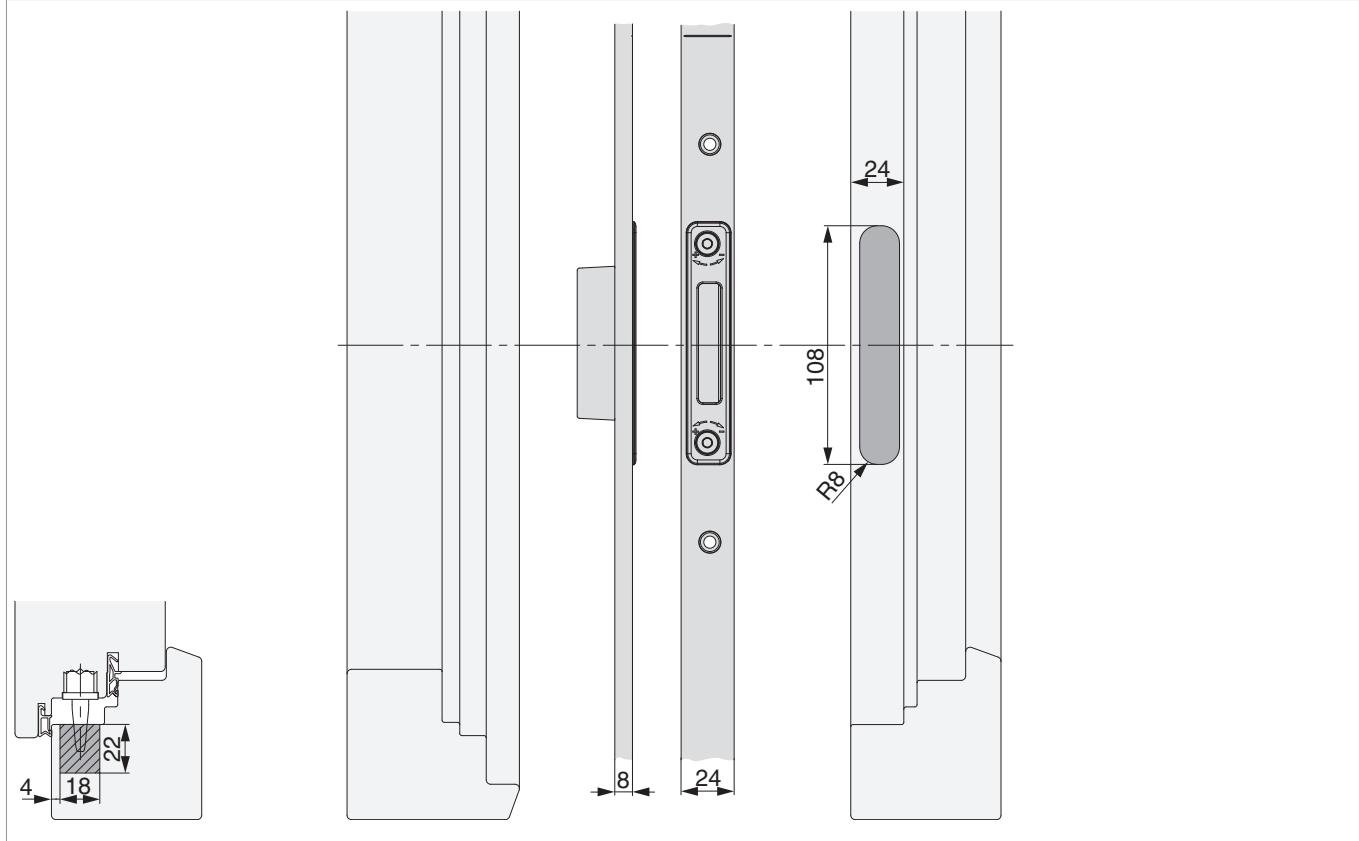



Dettaglio B

