

**MANIGLIONI**  
**PULL HANDLES**

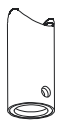

CODICE CODE AISI 304	Ø	A	B	C
800.16.500.300.60	16	500	300	66
800.16.700.500.60	16	700	500	66

CODICE CODE AISI 304	Ø	A	B	C
800.20.300.200.60	20	300	200	70
800.20.500.300.60	20	500	300	70
800.20.700.500.60	20	700	500	70
800.20.800.600.60	20	800	600	70
800.20.1200.900.60	20	1200	900	70
800.20.1600.1300.60	20	1600	1300	70



SUPPORTI DIRITTI  
STRAIGHT SUPPORTS

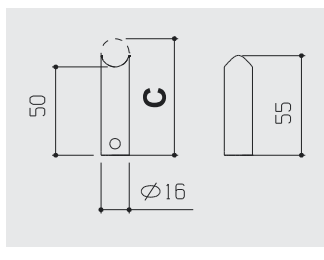

800.16

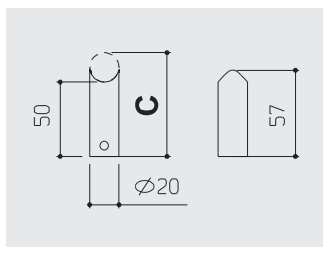

800.20

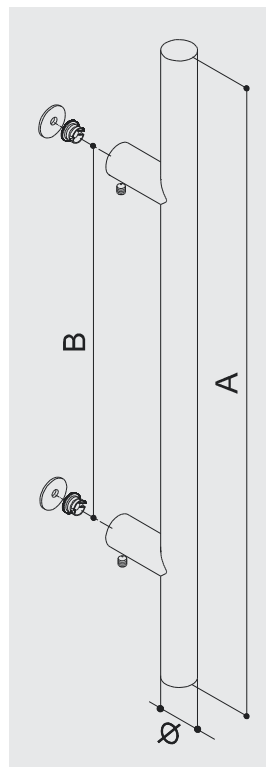

MATERIALE  
MATERIAL

**INOX**  
**AISI**  
**304**

FINITURA  
FINISH

**F60**

**INOX SATINATO SATIN S. STEEL**

ACCESSORI INCLUSI INCLUDED ACCESSORIES



BUSSOLE  
BOLDS

GRANI  
GRUB SCREWS

GUARNIZIONI  
GASKETS

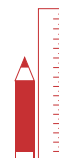

**SU MISURA**  
LUNGHEZZA E INTERASSE  
CON 2 O PIÙ SUPPORTI FINO A 3500 mm

**CUSTOMIZED**  
LENGTH AND WHEELBASE  
WITH 2 OR MORE SUPPORTS TILL 3500 mm

FINITURE e  
MATERIALE  
A RICHIESTA  
FINISHES AND  
MATERIAL  
ON REQUEST

**F62**  
INOX SATINATO  
SATIN S. STEEL



**INOX**  
**AISI**  
**316**

**F61**  
INOX LUCIDO  
POLISHED S. STEEL



**F NO**  
NERO OPACO RAL 9005  
MATT BLACK RAL 9005



**F BO**  
BIANCO OPACO RAL 9016  
OPAQUE WHITE RAL 9016



**F BL**  
BIANCO LUCIDO RAL 9010  
GLOSSY WHITE RAL 9010



**MANIGLIONI**  
**PULL HANDLES**



CODICE CODE  
**AISI 304**

800.25.300.200.60	25	300	200	75
800.25.400.300.60	25	400	300	75
800.25.500.300.60	25	500	300	75
800.25.600.400.60	25	600	400	75
800.25.700.500.60	25	700	500	75
800.25.800.600.60	25	800	600	75
800.25.1000.700.60	25	1000	700	75
800.25.1200.900.60	25	1200	900	75
800.25.1600.1300.60	25	1600	1300	75

Ø	A	B	C
25	300	200	75
25	400	300	75
25	500	300	75
25	600	400	75
25	700	500	75
25	800	600	75
25	1000	700	75
25	1200	900	75
25	1600	1300	75

CODICE CODE  
**AISI 316**

800.25.500.300.62	25	500	300	75
800.25.700.500.62	25	700	500	75
800.25.1200.900.62	25	1200	900	75

Ø	A	B	C
25	500	300	75
25	700	500	75
25	1200	900	75



SUPPORTI DIRITTI  
STRAIGHT SUPPORTS

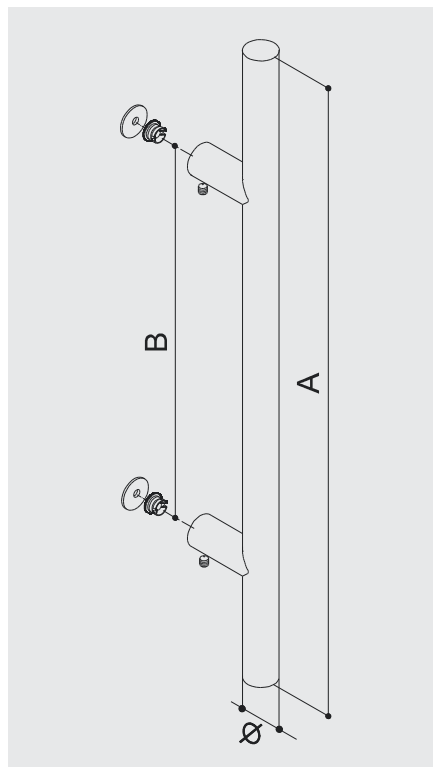
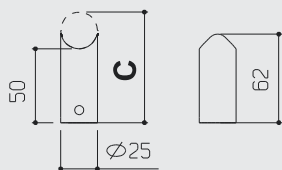

MATERIALE **INOX AISI 304** **INOX AISI 316**  
MATERIAL

FINITURA **F60** **F62**  
FINISH

**INOX SATINATO SATIN S. STEEL**

ACCESSORI INCLUSI INCLUDED ACCESSORIES



BUSSOLE  
BOLDS

GRANI  
GRUB SCREWS

GUARNIZIONI  
GASKETS



**SU MISURA**  
LUNGHEZZA E INTERASSE  
CON 2 O PIÙ SUPPORTI FINO A 3500 mm

**CUSTOMIZED**  
LENGTH AND WHEELBASE  
WITH 2 OR MORE SUPPORTS TILL 3500 mm

FINITURE  
A RICHIESTA  
FINISHES  
ON REQUEST

**F61**  
INOX LUCIDO  
POLISHED S. STEEL

**F NO**  
NERO OPACO RAL 9005  
MATT BLACK RAL 9005

**F BO**  
BIANCO OPACO RAL 9016  
OPAQUE WHITE RAL 9016

**F BL**  
BIANCO LUCIDO RAL 9010  
GLOSSY WHITE RAL 9010

**MANIGLIONI**  
**PULL HANDLES**

\* Maniglione con 3 supporti \* Pull handle with 3 supports



CODICE CODE AISI 304	Ø	A	B	C
800.30.300.210.60	30	300	210	80
800.30.400.300.60	30	400	300	80
800.30.500.300.60	30	500	300	80
800.30.600.400.60	30	600	400	80
800.30.700.500.60	30	700	500	80
800.30.800.600.60	30	800	600	80
800.30.1000.700.60	30	1000	700	80
800.30.1200.900.60	30	1200	900	80
800.30.1500.1300.60	30	1500	1300	80
800.30.2000.1800.3S.60*	30	2000	1800	80

CODICE CODE AISI 316	Ø	A	B	C
800.30.500.300.62	30	500	300	80
800.30.700.500.62	30	700	500	80
800.30.1200.900.62	30	1200	900	80



SUPPORTI DIRITTI  
STRAIGHT SUPPORTS

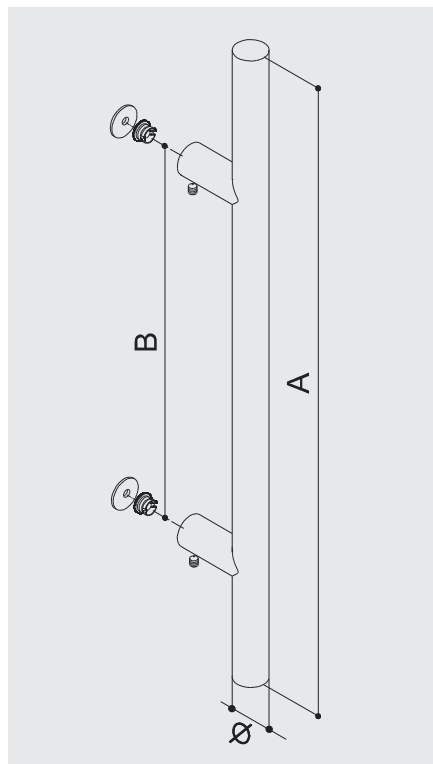
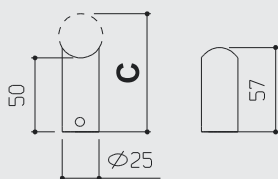

MATERIALE MATERIAL  
**INOX AISI 304** **INOX AISI 316**

FINITURA FINISH  
**F60** **F62**

**INOX SATINATO SATIN S. STEEL**

ACCESSORI INCLUSI INCLUDED ACCESSORIES



BUSSOLE BOLDS

GRANI GRUB SCREWS

GUARNIZIONI GASKETS



**SU MISURA**  
LUNGHEZZA E INTERASSE  
CON 2 O PIÙ SUPPORTI FINO A 3500 mm

**CUSTOMIZED**  
LENGTH AND WHEELBASE  
WITH 2 OR MORE SUPPORTS TILL 3500 mm



CODICE CODE AISI 304	Ø	A	B	C
800.35.700.500.60	35	700	500	85
800.35.1000.700.60	35	1000	700	85
800.35.1500.1300.60	35	1500	1300	85

CODICE CODE AISI 316	Ø	A	B	C
800.35.700.500.62	35	700	500	85
800.35.1000.700.62	35	1000	700	85
800.35.1500.1300.62	35	1500	1300	85



SUPPORTI DIRITTI  
STRAIGHT SUPPORTS

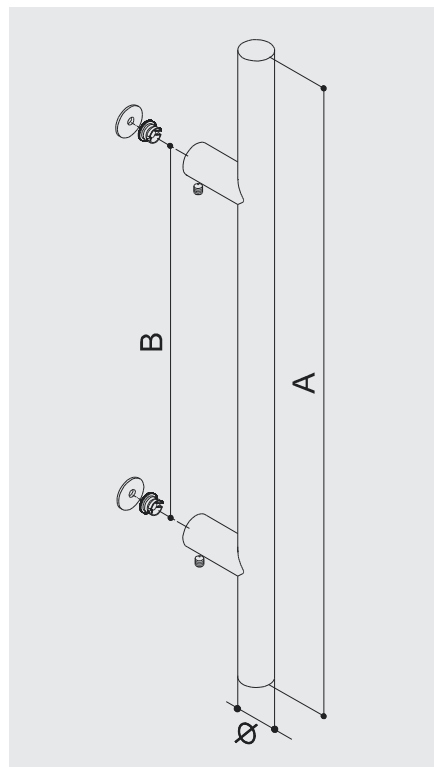
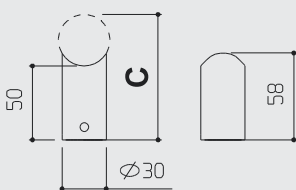

MATERIALE MATERIAL  
**INOX AISI 304** **INOX AISI 316**

FINITURA FINISH  
**F60** **F62**

**INOX SATINATO SATIN S. STEEL**

ACCESSORI INCLUSI INCLUDED ACCESSORIES



BUSSOLE  
BOLDS

GRANI  
GRUB SCREWS

GUARNIZIONI  
GASKETS

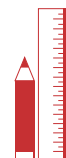

**SU MISURA**  
LUNGHEZZA E INTERASSE  
CON 2 O PIÙ SUPPORTI FINO A 3500 mm

**CUSTOMIZED**  
LENGTH AND WHEELBASE  
WITH 2 OR MORE SUPPORTS TILL 3500 mm

FINITURE  
A RICHIESTA  
FINISHES  
ON REQUEST

**F61**  
INOX LUCIDO  
POLISHED S. STEEL

**F NO**  
NERO OPACO RAL 9005  
MATT BLACK RAL 9005

**F BO**  
BIANCO OPACO RAL 9016  
OPAQUE WHITE RAL 9016

**F BL**  
BIANCO LUCIDO RAL 9010  
GLOSSY WHITE RAL 9010

**MANIGLIONI**  
**PULL HANDLES**



CODICE CODE AISI 304	Ø	A	B	C
800.40.700.500.60	40	700	500	90
800.40.1000.700.60	40	1000	700	90
800.40.1500.1300.60	40	1500	1300	90

CODICE CODE AISI 316	Ø	A	B	C
800.40.700.500.62	40	700	500	90
800.40.1000.700.62	40	1000	700	90
800.40.1500.1300.62	40	1500	1300	90

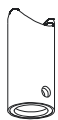

SUPPORTI DIRITTI  
STRAIGHT SUPPORTS

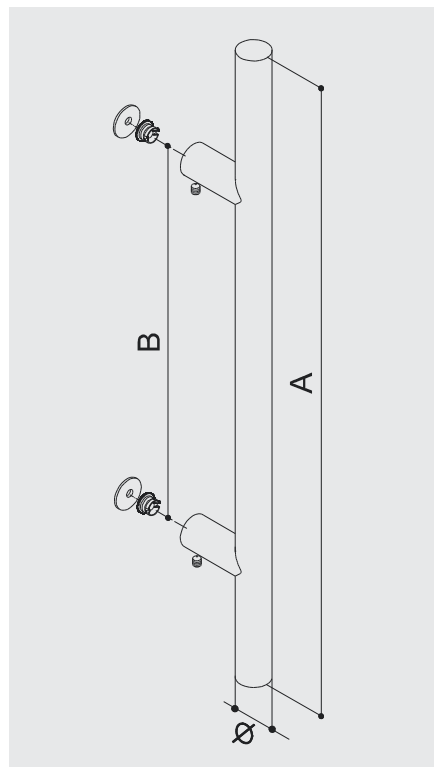
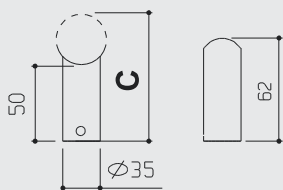

MATERIALE MATERIAL **INOX AISI 304** **INOX AISI 316**

FINITURA FINISH **F60** **F62**

**INOX SATINATO SATIN S. STEEL**

ACCESSORI INCLUSI INCLUDED ACCESSORIES



BUSSOLE  
BOLDS

GRANI  
GRUB SCREWS

GUARNIZIONI  
GASKETS



**SU MISURA**  
LUNGHEZZA E INTERASSE  
CON 2 O PIÙ SUPPORTI FINO A 3500 mm

**CUSTOMIZED**  
LENGTH AND WHEELBASE  
WITH 2 OR MORE SUPPORTS TILL 3500 mm